

195-0898

DLS239 LED

**we-ef**



#### Description

IP66, Class I. IK10. Marine-grade, die-cast aluminium alloy. 5CE superior corrosion protection + primer including PCS hardware. Polycarbonate lens. Silicone rubber gasket. Two cable entries.

Integral EC electronic converter. Advanced thermal management protects LEDs while optimising lumens output.

Weight	3.70 kg
Light distribution	diffused distribution
Light source	LED-FT-28W / 800 mA - 2700 K
CRI	80
Power supply	EC
LEDs	1
Rated input power	31 W
<b>Rated lumens (lm)</b>	
LED Lumen	1150.2
Total Lumen	1150.2
Ta	25
<b>Nominal Lumen (lm)</b>	
LED Lumen	4570
Total Lumen	4570
Tc	25

#### WE-EF LIGHTING Pty Ltd

6/13 Downard Street, 3195 Braeside, Victoria - Phone: +61 3 8587 0444 - Fax: +61 3 8587 0499

info.australia@we-ef.com - <https://we-ef.com/aus>

Subject to technical changes and errors. - Generated on 23/11/2024

195-0898

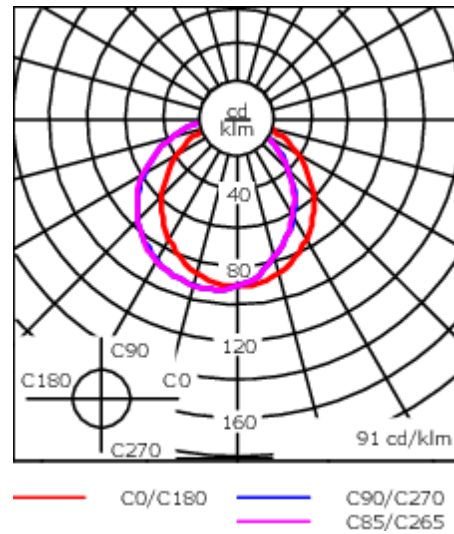
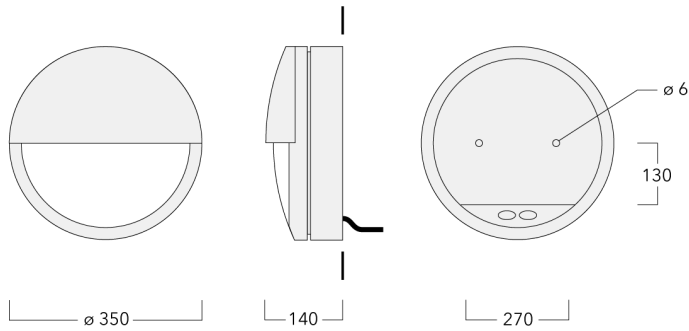

DLS239 LED

**we-ef**



## Specifications

### Material description

Body	Marine-grade die-cast aluminium alloy
Lens	Polycarbonate main lens
Colours	 RAL9004 Signal black  RAL9006 White aluminium  RAL9007 Grey aluminium
Gasket	Silicone rubber gasket
Fasteners	PCS Polymer Coated Stainless Steel Hardware (unpainted)
Ingress protection	IP66
Impact resistance	IK10
Corrosion resistance	5CE+Primer

### Electrical description

Power supply	230V / 50 Hz
Driver / Ballast	Integral EC electronic converter

### Additional information

Lifetime	Ta=40° L70B50 > 50000h
Warranty	The product is supplied with 10-year warranty. Please refer to the LED Warranty Statement located on <a href="http://www.we-ef.com">www.we-ef.com</a> for further details.

**WE-EF LIGHTING Pty Ltd**

6/13 Downard Street, 3195 Braeside, Victoria - Phone: +61 3 8587 0444 - Fax: +61 3 8587 0499

info.australia@we-ef.com - <https://we-ef.com/aus>

Subject to technical changes and errors. - Generated on 23/11/2024