

108-2544

PIA240 LED

we-ef



Description

IP66, Class I. Class II on request. IK08. Marine-grade, die-cast aluminium alloy. 5CE superior corrosion protection including PCS hardware. Silicone CCG® Controlled Compression Gasket. Safety glass, hinged. Integral EC electronic converter. CAD-optimised optics for superior illumination and glare control. OLC® One LED Concept. Factory installed LED circuit board. Luminaire +15°/-30° tiltable.

Optional 2200 K version available. To be specified at time of ordering.

| | |
|--------------------|---------------------------------|
| Weight | 12.70 kg |
| Light distribution | asymmetric, forward throw [A60] |
| Light source | LED-24/72W / 1050 mA - 2700 K |
| CRI | 80 |
| Power supply | EC |
| LEDs | 24 |
| Rated input power | 81 W |

Nominal Lumen (lm)

| | |
|-------------|------|
| LED Lumen | 410 |
| Total Lumen | 9840 |
| Tj | 85 |

Rated lumens (lm)

| | |
|-------------|-------|
| LED Lumen | 306.3 |
| Total Lumen | 7351 |
| Ta | 25 |

Fagerhult Lighting Ltd

33-34 Dolben Street, SE1 0UQ London, United Kingdom

<https://we-ef.com/uk>

Subject to technical changes and errors. - Generated on 23/11/2024

108-2544



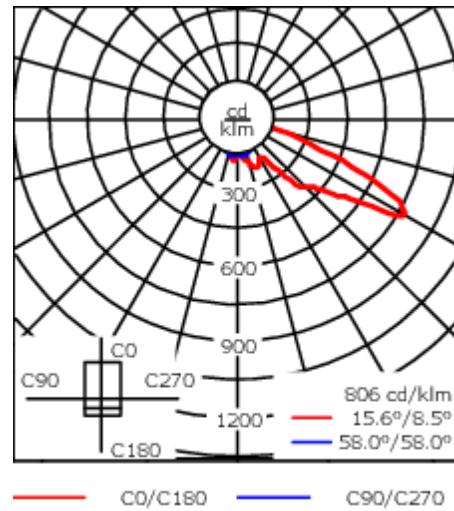
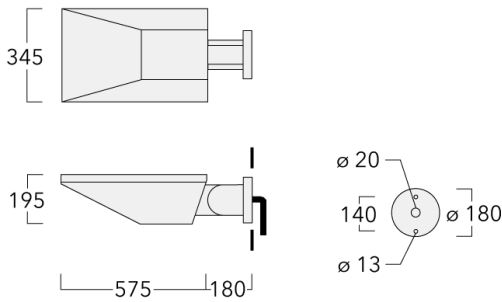

PIA240 LED

we-ef



Specifications

Material description

| | |
|----------------------|---|
| Body | Marine-grade die-cast aluminium alloy |
| Lens | Safety glass lens, hinged |
| Colours |  RAL9004 Signal black  RAL9006 White aluminium  RAL9007 Grey aluminium  RAL7016 Anthracite grey  RAL9016 Traffic white |
| Gasket | Silicone CCG® Controlled Compression Gasket |
| Fasteners | PCS Polymer Coated Stainless Steel Hardware |
| Ingress protection | IP66 |
| Impact resistance | IK08 |
| Corrosion resistance | 5CE |

Electrical description

| | |
|------------------|----------------------------------|
| Power supply | 220-240V / 50-60 Hz |
| Driver / Ballast | Integral EC electronic converter |

Additional information

| | |
|-------------------------|------------------------|
| Lifetime | Ta=25° L90B10 > 90000h |
| Energy efficiency class | C-D (Light source) |

Fagerhult Lighting Ltd

33-34 Dolben Street, SE1 0UQ London, United Kingdom

<https://we-ef.com/uk>

Subject to technical changes and errors. - Generated on 23/11/2024