



### Description

IP69. IK10+. Stainless steel construction including PCS hardware. Safety glass lens, max. load 5 tonnes. Luminaire can be driven over at low speed. Silicone rubber gasket. Anti-wick technology, equipped with a cable gland and 1.5 meters of flexible, PVC-free cable.

Integral EC electronic converter. Advanced thermal management protects LEDs while optimising lumens output. Removable LED boards for upgrading. CAD-optimised optics for superior illumination and glare control. OLC® One LED Concept. 20° tiltable and 355° rotatable. 1-10 V analogue dimming or DALI interface available on request.

Luminaire installation blackout and sealable junction box included in supply.

Weight	3.70 kg
Light distribution	symmetric, medium beam [M]
Light source	LED-3/9W / 1050 mA - 2700 K
CRI	80
Power supply	EC
LEDs	3
Rated input power	11 W
<b>Nominal Lumen (lm)</b>	
LED Lumen	410
Total Lumen	1230
Tj	85
<b>Rated lumens (lm)</b>	
LED Lumen	306.8
Total Lumen	920.5
Ta	25

185-7784

ETC120-GB LED

**we-ef**

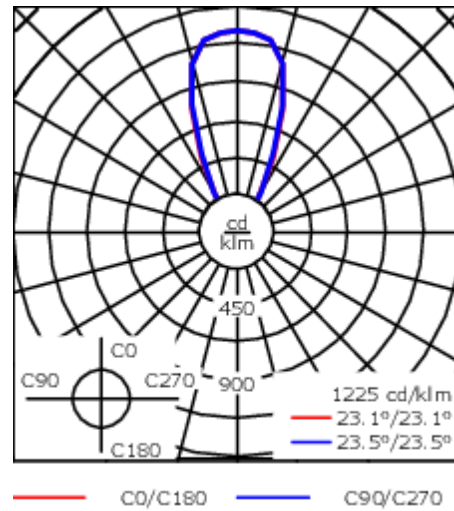
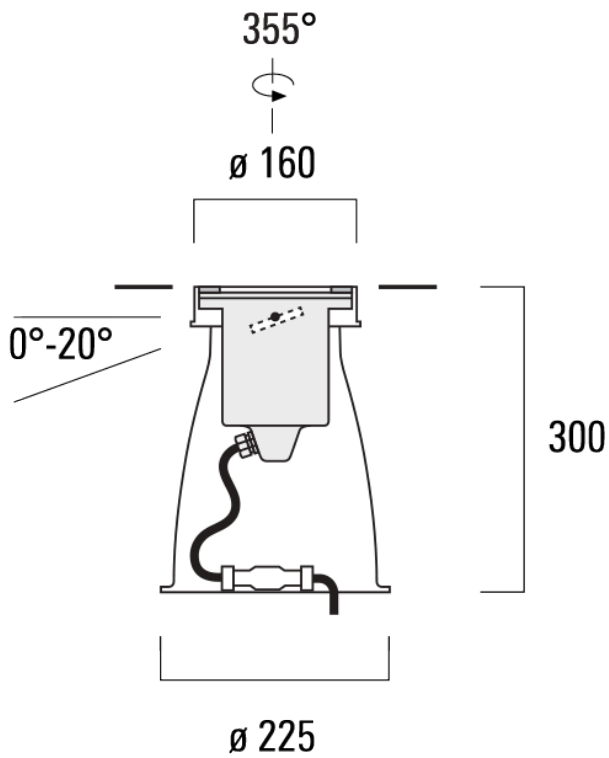

## Specifications

### Material description

Body	Stainless steel construction
Lens	Safety glass lens, max. load 5 tonnes
Colours	 Stainless Steel
Gasket	Silicone rubber gasket
Fasteners	PCS hardware
Ingress protection	IP69
Impact resistance	IK10+

### Electrical description

Driver / Ballast	Integral EC electronic converter
------------------	----------------------------------

### Additional information

#### WE-EF LIGHTING (Thailand) Co., Ltd.

57 Moo 5, Kingkaew Rd., Bangplee, 10540 Samutprakarn - Phone: +66 2 738 96 20 - Fax: +66 2 738 96 29

<https://we-ef.com/asia>

Subject to technical changes and errors. - Generated on 23/11/2024

**185-7784**

**ETC120-GB LED**

**we-ef**

## **Control**

### **DALI interface**

Description	Part ID
DALI	430-0013

### **1-10 V analogue dimming interface**

Description	Part ID
1-10 V analogue dimming interface	430-0011

**WE-EF LIGHTING (Thailand) Co., Ltd.**

57 Moo 5, Kingkaew Rd., Bangplee, 10540 Samutprakarn - Phone: +66 2 738 96 20 - Fax: +66 2 738 96 29

<https://we-ef.com/asia>

Subject to technical changes and errors. - Generated on 23/11/2024

185-7784

ETC120-GB LED

**we-ef**

## Mounting Accessories

### Installation cover

Description	Part ID	C1
Installation cover BE	185-0796	160



C1

**WE-EF LIGHTING (Thailand) Co., Ltd.**

57 Moo 5, Kingkaew Rd., Bangplee, 10540 Samutprakarn - Phone: +66 2 738 96 20 - Fax: +66 2 738 96 29

<https://we-ef.com/asia>

Subject to technical changes and errors. - Generated on 23/11/2024

185-7784

ETC120-GB LED

**we-ef**

## Optical Accessories

### Honeycomb louvre

Description	Part ID	C1
Honeycomb louvre IW	185-2869	60

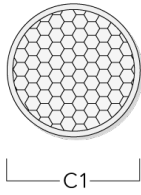

### Linear spread lens

Description	Part ID	C1
Linear spread lens IO-180	185-9612	60

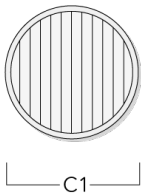

**WE-EF LIGHTING (Thailand) Co., Ltd.**

57 Moo 5, Kingkaew Rd., Bangplee, 10540 Samutprakarn - Phone: +66 2 738 96 20 - Fax: +66 2 738 96 29

<https://we-ef.com/asia>

Subject to technical changes and errors. - Generated on 23/11/2024

**Flood lens**

---

Description	Part ID	C1
Flood lens IO-360	185-9613	60

---



---

**Linear louvre**

---

Description	Part ID	Additional information	C1
Linear louvre IL	185-9614	ETC320	60

---



185-7784

ETC120-GB LED

**we-ef**

**Colour filter**

---

Description	Part ID
Colour filter IF	on request

---

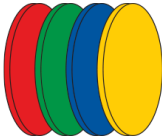

---

**Colour correction filter**

---

Description	Part ID
IF-3000K > 2400K	185-9973

---

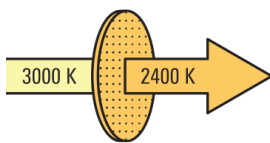

---

**WE-EF LIGHTING (Thailand) Co., Ltd.**

57 Moo 5, Kingkaew Rd., Bangplee, 10540 Samutprakarn - Phone: +66 2 738 96 20 - Fax: +66 2 738 96 29

<https://we-ef.com/asia>

Subject to technical changes and errors. - Generated on 23/11/2024