

139-2364

FLC210 LED

**we-ef**



### Description

IP66, Class I. Class II on request. IK07. Marine-grade, die-cast aluminium alloy. 5CE superior corrosion protection including PCS hardware. Silicone CCG® Controlled Compression Gasket. Safety glass lens. One cable gland. Second gland for through wiring on request. Integral EC electronic converter, thermally separated. CAD-optimised optics for superior illumination and glare control. OLC® One LED Concept. Factory installed LED circuit board. DALI Interface. Eco Step Dim® on request. Maximum one internal optical accessory possible.

Weight	2.00 kg
Light distribution	symmetric, medium beam [M]
Light source	LED-3/6W / 180 mA - 2700 K
CRI	80
Power supply	EC
LEDs	3
Rated input power	7.5 W
<b>Nominal Lumen (lm)</b>	
LED Lumen	260
Total Lumen	780
Tj	85
<b>Rated lumens (lm)</b>	
LED Lumen	228
Total Lumen	684.1
Ta	25

### Fagerhult Lighting Ltd

33-34 Dolben Street, SE1 0UQ London, United Kingdom

<https://we-ef.com/uk>

Subject to technical changes and errors. - Generated on 23/11/2024

139-2364



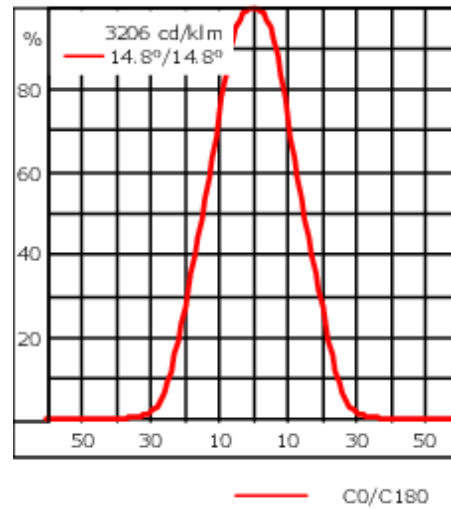
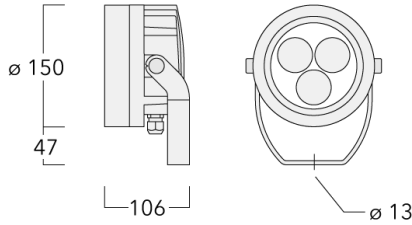

FLC210 LED

we-ef



## Specifications

### Material description

Body	Marine-grade, die-cast aluminium alloy
Lens	Safety glass lens
Colours	<ul style="list-style-type: none"><li> RAL9004 Signal black</li><li> RAL9006 White aluminium</li><li> RAL9007 Grey aluminium</li><li> RAL7016 Anthracite grey</li><li> RAL9016 Traffic white</li></ul>
Gasket	Silicone CCG® Controlled Compression Gasket
Fasteners	PCS Polymer Coated Stainless Steel Hardware
Ingress protection	IP66
Impact resistance	IK07
Corrosion resistance	5CE
Windage	0.018 m <sup>2</sup>

### Electrical description

Power supply	220-240V / 50-60 Hz
Driver / Ballast	Standard. Optional DALI version available. To be specified at time of ordering.
Power factor	> 0.9
Surge protection	SP10

#### Fagerhult Lighting Ltd

33-34 Dolben Street, SE1 0UQ London, United Kingdom

<https://we-ef.com/uk>

Subject to technical changes and errors. - Generated on 23/11/2024

**139-2364**

**FLC210 LED**

**we-ef**

**Additional information**

---

Lifetime Ta=25° L90B10 > 90000h

Energy efficiency class D-E (Light source)

---

**Fagerhult Lighting Ltd**

33-34 Dolben Street, SE1 0UQ London, United Kingdom

<https://we-ef.com/uk>

Subject to technical changes and errors. - Generated on 23/11/2024

## Mounting Accessories

### Pole clamp TS

Description	Part ID	D1	Weight (kg)	D
TS1-2/M12 Pole clamp, single (Ø 76-89)	147-0543	76-89	1.40	76-89

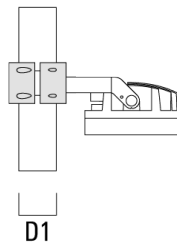
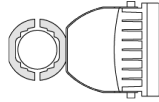

### Pole clamp PC

Description	Part ID	D1	Weight (kg)
PC2 76-89/60 Pole clamp, double (Ø 76-89)	139-2703	76-89	1.00

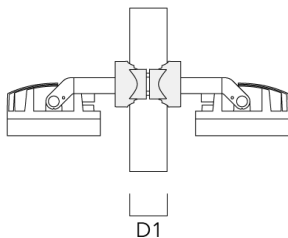
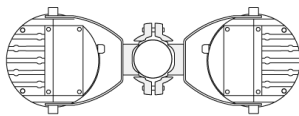

**FLC210 LED**

Description	Part ID	D1	Weight (kg)
PC1 76-89/60 Pole clamp, single (Ø 76-89)	139-2702	76-89	1.00

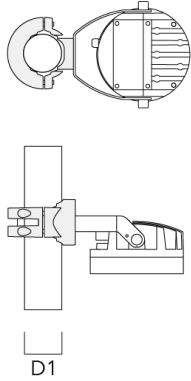

PC2 102-114/60 Pole clamp, double (Ø 102-114)	139-2707	102-114	1.20
---	----------	---------	------

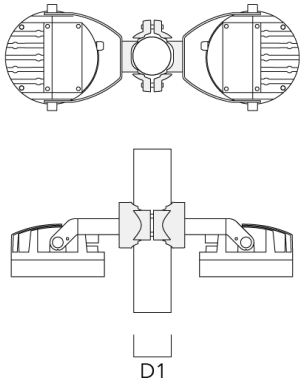

**FLC210 LED**

Description	Part ID	D1	Weight (kg)
PC1 102-114/60 Pole clamp, single (Ø 102-114)	139-2706	102-114	1.20

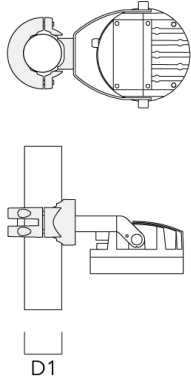

PC2 114-133/60 Pole clamp, double (Ø 114-133)	139-2709	114-133	1.40
--	----------	---------	------

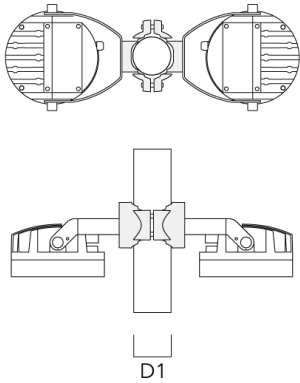

**FLC210 LED**

Description	Part ID	D1	Weight (kg)
PC1 114-133/60 Pole clamp, single (Ø 114-133)	139-2708	114-133	1.40



PC2 82-109/60 Pole camp, double (Ø 82-109)	139-2705	82-109	1.10
--	----------	--------	------

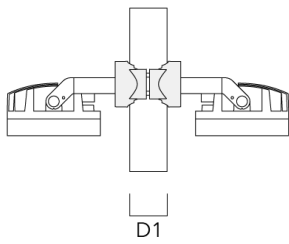
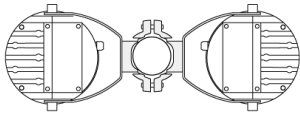

**139-2364**

**FLC210 LED**

**we-ef**

---

Description	Part ID	D1	Weight (kg)
PC1 82-109/60 Pole camp, single (Ø 82-109)	139-2704	82-109	1.10

---



D1



139-2364

FLC210 LED

**we-ef**

## Optical Accessories

### Linear spread lens

Description	Part ID	C1
IO-180-FLC210-LED	139-2404	100



### Honeycomb louvre

Description	Part ID	C1
IW-FLC210-LED - [EE][EES]	139-2405	100



#### Fagerhult Lighting Ltd

33-34 Dolben Street, SE1 0UQ London, United Kingdom

<https://we-ef.com/uk>

Subject to technical changes and errors. - Generated on 23/11/2024

**Glare shield**

---

Description	Part ID	A	C1
ES-FLC210-LED	139-2406	86	149

---

**Snoot**

---

Description	Part ID	A	C1
ET-FLC210-LED	139-2407	86	149

---

