

139-2378

FLC210 LED

we-ef



Description

IP66. Classe I. Classe II sur demande. IK07. Corps en fonte d'aluminium. Visserie inox avec traitement PCS. Protection contre la corrosion 5CE. Joint silicone. Verre de sécurité.

Poids	2.00 kg
Distribution de la lumière	faisceau symétrique, médium [M]
Source lumineuse	LED-3/9W / 250 mA - 4000 K
IRC	80
Alimentation électrique	ballast électronique
LEDs	3
Rated input power	11 W
Flux lumineux nominal (lm)	
LED Lumen	390
Total Lumen	1170
Tj	85
Rated lumens (lm)	
LED Lumen	342.1
Total Lumen	1026.2
Ta	25

WE-EF Switzerland AG

Himmelrichstrasse 6, 6003 Luzern - Téléphone: +41 22 752 49 94

info.switzerland@we-ef.com - https://we-ef.com/ch_fr

Sous réserve de modifications techniques et d'erreurs. - Généré le 23/10/2024

139-2378



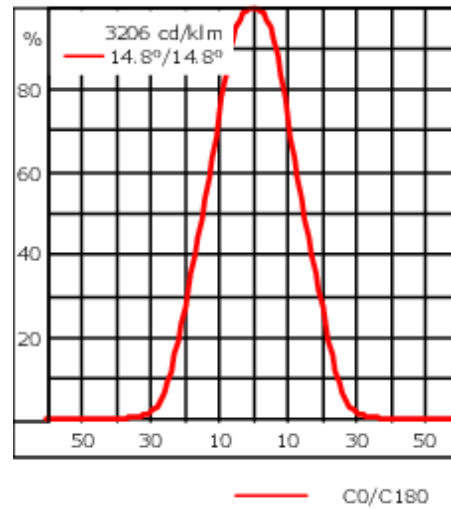
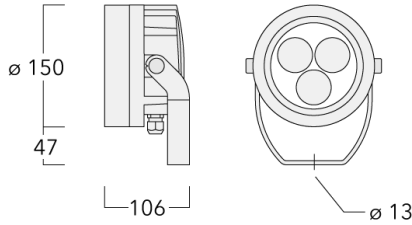

FLC210 LED

we-ef



Spécifications

Description du matériel

Corps	Corps en fonte d'aluminium
Lentille	Verre de sécurité
Couleurs	 RAL9004 Noir de sécurité  RAL9007 Aluminium gris  RAL7016 Gris anthracite  RAL9016 Blanc signalisation
Joint	Joint silicone CCG®
Visserie	PCS Inox avec revêtement polymère
IP	IP66
IK	IK07
Protection contre la corrosion	5CE
Surface exposée au vent	0.018 m ²

Description électrique

Driver	Standard - version DALI disponible en option
--------	--

WE-EF Switzerland AG

Himmelrichstrasse 6, 6003 Luzern - Téléphone: +41 22 752 49 94

info.switzerland@we-ef.com - https://we-ef.com/ch_fr

Sous réserve de modifications techniques et d'erreurs. - Généré le 23/10/2024

139-2378

FLC210 LED

we-ef

Informations complémentaires

Durée de vie Ta=25° L90B10 > 90000h

Classe d'efficacité
énergétique D-E

WE-EF Switzerland AG

Himmelrichstrasse 6, 6003 Luzern - Téléphone: +41 22 752 49 94

info.switzerland@we-ef.com - https://we-ef.com/ch_fr

Sous réserve de modifications techniques et d'erreurs. - Généré le 23/10/2024

Accessoires d'installation

Collier pour mâts TS

Description	Référence	D1	Poids (kg)	D
TS1-2/M12 collier simple pour tube (Ø 76-89)	147-0543	76-89	1.40	76-89

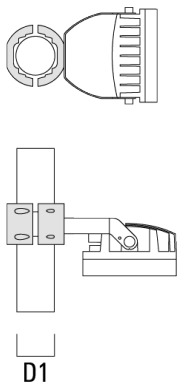

Collier pour mâts PC

Description	Référence	D1	Poids (kg)
PC2 76-89/60 collier double pour tube (Ø 76-89)	139-2703	76-89	1.00

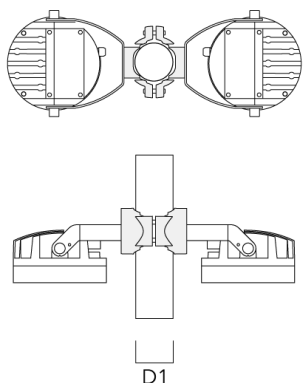

139-2378

FLC210 LED

we-ef

Description	Référence	D1	Poids (kg)
PC1 76-89/60 collier simple (Ø 76-89)	139-2702	76-89	1.00

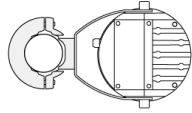

PC2 102-114/60 collier double pour tube (Ø 102-114)	139-2707	102-114	1.20
---	----------	---------	------

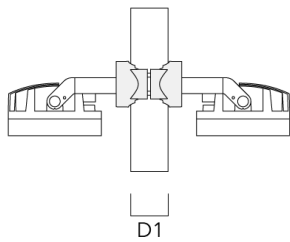
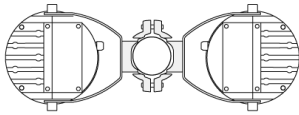

WE-EF Switzerland AG

Himmelrichstrasse 6, 6003 Luzern - Téléphone: +41 22 752 49 94

info.switzerland@we-ef.com - https://we-ef.com/ch_fr

Sous réserve de modifications techniques et d'erreurs. - Généré le 23/10/2024

Description	Référence	D1	Poids (kg)
PC1 102-114/60 collier simple (Ø 102-114)	139-2706	102-114	1.20



PC2 114-133/60 collier double pour tube (Ø 114-133)	139-2709	114-133	1.40
---	----------	---------	------

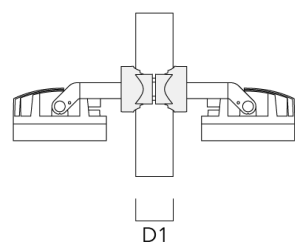
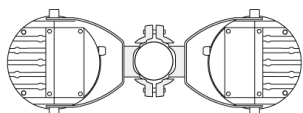

Description	Référence	D1	Poids (kg)
PC1 114-133/60 collier simple (Ø 114-133)	139-2708	114-133	1.40



PC2 82-109/60 collier double pour tube (Ø 82-109)	139-2705	82-109	1.10
---	----------	--------	------

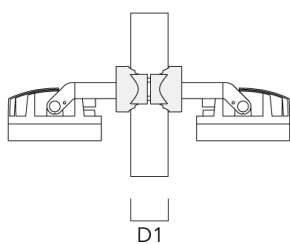
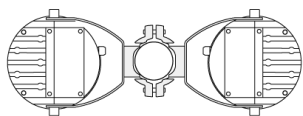

139-2378

FLC210 LED

we-ef

Description	Référence	D1	Poids (kg)
PC1 82-109/60 collier simple (Ø 82-109)	139-2704	82-109	1.10



WE-EF Switzerland AG

Himmelrichstrasse 6, 6003 Luzern - Téléphone: +41 22 752 49 94

info.switzerland@we-ef.com - https://we-ef.com/ch_fr

Sous réserve de modifications techniques et d'erreurs. - Généré le 23/10/2024

Accessoires Optiques

Lentille ovalisante

Description	Référence	C1
IO-180-FLC210-LED	139-2404	100

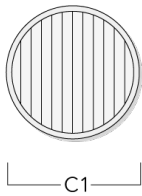

Grille nid d'abeille

Description	Référence	C1
IW-FLC210-LED - [EE][EES]	139-2405	100



Visière

WE-EF Switzerland AG

Himmelrichstrasse 6, 6003 Luzern - Téléphone: +41 22 752 49 94

info.switzerland@we-ef.com - https://we-ef.com/ch_fr

Sous réserve de modifications techniques et d'erreurs. - Généré le 23/10/2024

Description	Référence	A	C1
ES-FLC210-LED	139-2406	86	149

Canon anti-éblouissement

Description	Référence	A	C1
ET-FLC210-LED	139-2407	86	149

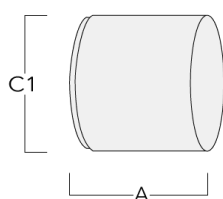

139-2378

FLC210 LED

WE-EF Switzerland AG

Himmelrichstrasse 6, 6003 Luzern

Téléphone: +41 22 752 49 94

info.switzerland@we-ef.com

https://we-ef.com/ch_fr

Sous réserve de modifications techniques et d'erreurs.

Généré le 23/10/2024