

**139-2400**

**FLC210 LED**

**we-ef**



**Description**

IP66, Class I. IK07. Marine-grade, die-cast aluminum alloy. 5CE superior corrosion protection including PCS hardware. Silicone CCG® Controlled Compression Gasket. Safety glass lens. One cable gland. Second gland for through wiring on request. Integral driver, thermally separated. CAD-optimized optics for superior illumination and glare control. OLC® One LED Concept. Factory installed LED circuit board. 0-10V Dimming comes standard with luminaire.

True Amber upon request.

Maximum one internal optical accessory possible, to be specified at time of ordering.

Specify product with 7 Digit product code - Finish Color. Accessories, such as mounting, optical, and electrical, must be specified separately.

Example: XXX-XXXX - 9004 (Black)

+ XXX-XXXX (Accessory 1)

|                    |                                  |
|--------------------|----------------------------------|
| Weight             | 4.40 lb                          |
| Light distribution | symmetric, very narrow beam [VN] |
| Light source       | LED-3/12W / 350 mA - 2700 K      |
| CRI                | 80                               |
| Power supply       | electronic gear                  |
| LEDs               | 3                                |
| Rated input power  | 13.9 W                           |

**Nominal Lumen (lm)**

|             |      |
|-------------|------|
| LED Lumen   | 490  |
| Total Lumen | 1470 |
| Tj          | 85   |

**Rated lumens (lm)**

|             |        |
|-------------|--------|
| LED Lumen   | 435.5  |
| Total Lumen | 1306.4 |
| Ta          | 25     |

**WE-EF LIGHTING USA, LLC**

410-D Keystone Drive, 15086 Warrendale, PA 15086 - Phone: +1 724 742 0030

customersupport.usa@we-ef.com - <https://we-ef.com/us>

Subject to technical changes and errors. - Generated on 11/23/2024

139-2400

FLC210 LED

**we-ef**

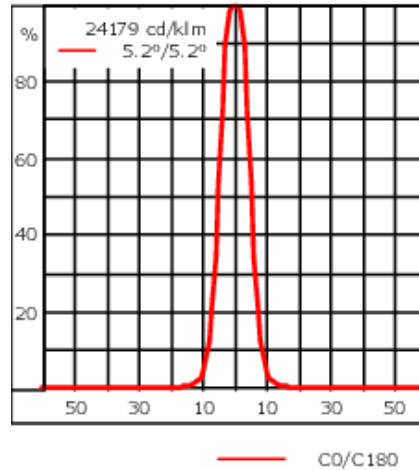
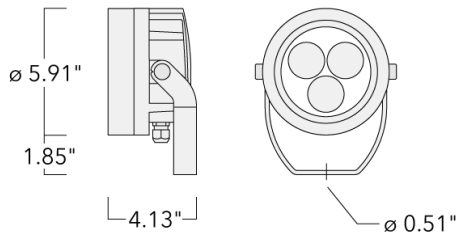

## Specifications

### Material description

|                      |   |
|----------------------|---|
| Body                 | Marine-grade, die-cast aluminium alloy  |
| Lens                 | Safety glass lens   |
| Colors               | <div style="display: flex; flex-direction: column; gap: 5px;"> <div><span style="display: inline-block; width: 15px; height: 15px; background-color: black; margin-right: 5px;"></span> RAL9004 Black</div> <div><span style="display: inline-block; width: 15px; height: 15px; background-color: grey; margin-right: 5px;"></span> RAL9007 Grey Metallic</div> <div><span style="display: inline-block; width: 15px; height: 15px; background-color: white; margin-right: 5px;"></span> RAL9016 White</div> <div><span style="display: inline-block; width: 15px; height: 15px; background-color: darkgrey; margin-right: 5px;"></span> RAL8019 Dark Bronze</div> </div> |
| Gasket               | Silicone CCG® Controlled Compression Gasket   |
| Fasteners            | PCS Polymer Coated Stainless Steel Hardware (unpainted)   |
| Ingress protection   | IP66  |
| Impact resistance    | IK07  |
| Corrosion resistance | 5CE   |
| Windage              | 0.194 ft <sup>2</sup>   |

### Electrical description

|                  |                                       |
|------------------|---------------------------------------|
| Power supply     | Integral [ECG] LED driver in 120-277V |
| Driver / Ballast | Integral 0-10V LED Driver             |
| Power factor     | > 0.9                                 |

#### WE-EF LIGHTING USA, LLC

410-D Keystone Drive, 15086 Warrendale, PA 15086 - Phone: +1 724 742 0030

customersupport.usa@we-ef.com - <https://we-ef.com/us>

Subject to technical changes and errors. - Generated on 11/23/2024

**139-2400**

**FLC210 LED**

**we-ef**

**Additional information**

---

Lifetime Ta=25°/40° L90B10 > 90000h

Listings Contact WE-EF USA for ETL/UL certification status.

---

**WE-EF LIGHTING USA, LLC**

410-D Keystone Drive, 15086 Warrendale, PA 15086 - Phone: +1 724 742 0030  
customersupport.usa@we-ef.com - <https://we-ef.com/us>

Subject to technical changes and errors. - Generated on 11/23/2024

139-2400

FLC210 LED

**we-ef**

## Mounting Accessories

### Pole clamp TS

| Description                              | Part ID  | D1       | Weight (lb) | D     |
|--|----------|----------|-------------|-------|
| TS1-2/M12 Pole clamp, single (Ø 3"-3.5") | 147-0543 | 3.0-3.50 | 3.31        | 76-89 |

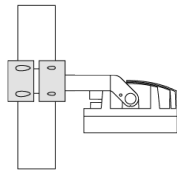
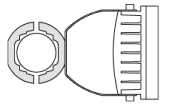

D1

**WE-EF LIGHTING USA, LLC**

410-D Keystone Drive, 15086 Warrendale, PA 15086 - Phone: +1 724 742 0030  
customersupport.usa@we-ef.com - <https://we-ef.com/us>

Subject to technical changes and errors. - Generated on 11/23/2024

**Junction box**

| Description                            | Part ID  | Additional information   | A    | B    | C1   | Weight (lb) |
|--|----------|--|------|------|------|-------------|
| Junction box JB20 - Cable side entries | 310-9013 | Junction boxes are made from marine-grade, die-cast aluminium alloy. IK10. IP66. For side entries and suitable to be used with cable glands. | 7.09 | 5.63 | 2.01 | 2.25        |

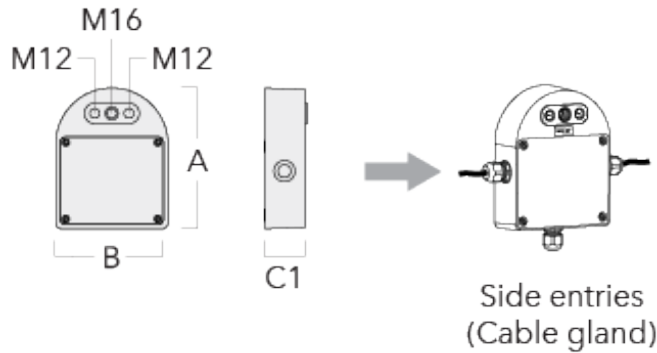

|  |          |  |      |      |      |      |
|--|----------|--|------|------|------|------|
| Junction box JB20 - Conduit side entries | 310-9014 | Junction boxes are made from marine-grade, die-cast aluminium alloy. IK10. IP66. For side entries and suitable to be used with conduits. | 7.09 | 5.63 | 2.01 | 2.25 |
|--|----------|--|------|------|------|------|

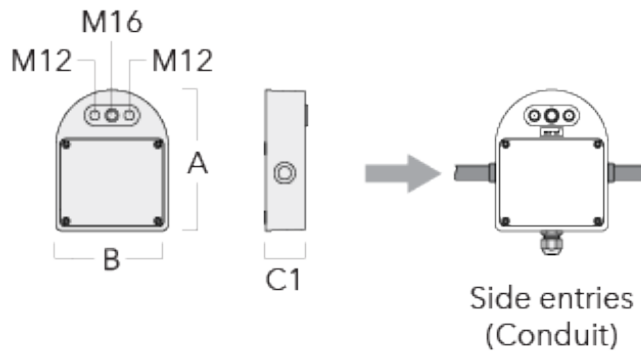

139-2400

**we-ef**

FLC210 LED

**Pole clamp PC**

---

| Description                                 | Part ID  | D1       | Weight (lb) |
|---|----------|----------|-------------|
| PC2 76-89/60 Pole clamp, double (Ø 3"-3.5") | 139-2703 | 3.0-3.50 | 2.20        |

---

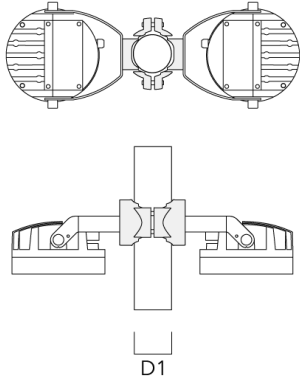

---

|   |          |          |      |
|---|----------|----------|------|
| PC1 76-89/60 Pole clamp, single (Ø 3"-3.5") | 139-2702 | 3.0-3.50 | 2.20 |
|---|----------|----------|------|

---

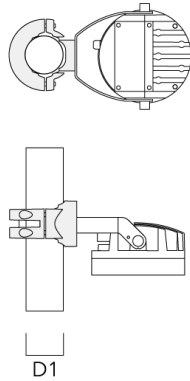

**WE-EF LIGHTING USA, LLC**

410-D Keystone Drive, 15086 Warrendale, PA 15086 - Phone: +1 724 742 0030

customersupport.usa@we-ef.com - <https://we-ef.com/us>

Subject to technical changes and errors. - Generated on 11/23/2024

139-2400

**we-ef**

FLC210 LED

---

| Description                                      | Part ID  | D1       | Weight (lb) |
|--|----------|----------|-------------|
| PC2 102-114/60 Pole clamp, double<br>(Ø 4"-4.5") | 139-2707 | 4.0-4.50 | 2.65        |

---

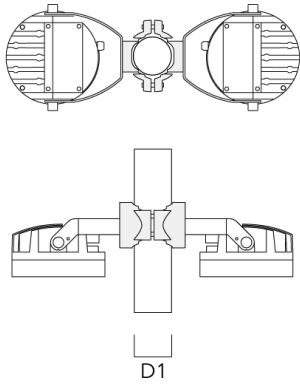

---

|  |          |          |      |
|--|----------|----------|------|
| PC1 102-114/60 Pole clamp, single<br>(Ø 4"-4,5") | 139-2706 | 4.0-4.50 | 2.65 |
|--|----------|----------|------|

---

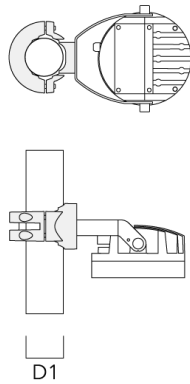

**WE-EF LIGHTING USA, LLC**

410-D Keystone Drive, 15086 Warrendale, PA 15086 - Phone: +1 724 742 0030

customersupport.usa@we-ef.com - <https://we-ef.com/us>

Subject to technical changes and errors. - Generated on 11/23/2024

139-2400

FLC210 LED

**we-ef**

---

| Description   | Part ID  | D1       | Weight (lb) |
|---|----------|----------|-------------|
| PC2 114-133/60 Pole clamp, double<br>(Ø 4.5"-5.25") | 139-2709 | 4.5-5.25 | 3.10        |

---

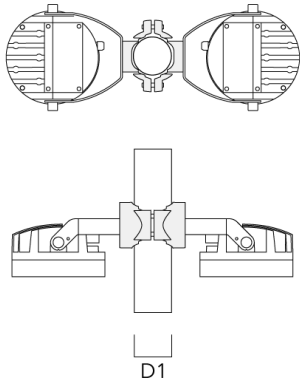

---

|   |          |          |      |
|---|----------|----------|------|
| PC1 114-133/60 Pole clamp, single<br>(Ø 4.5"-5.25") | 139-2708 | 4.5-5.25 | 3.10 |
|---|----------|----------|------|

---

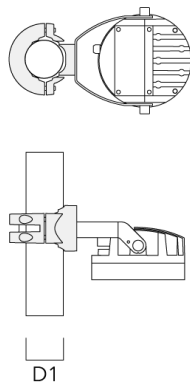

**WE-EF LIGHTING USA, LLC**

410-D Keystone Drive, 15086 Warrendale, PA 15086 - Phone: +1 724 742 0030

customersupport.usa@we-ef.com - <https://we-ef.com/us>

Subject to technical changes and errors. - Generated on 11/23/2024



139-2400

**we-ef**

FLC210 LED

---

| Description   | Part ID  | D1        | Weight (lb) |
|---|----------|-----------|-------------|
| PC2 82-109/60 Pole clamp, double<br>(Ø 3.25"-4.25") | 139-2705 | 3.20-4.30 | 2.40        |

---



---

|   |          |           |      |
|---|----------|-----------|------|
| PC1 82-109/60 Pole camp, single (Ø<br>3.25"-4.3") | 139-2704 | 3.20-4.30 | 2.40 |
|---|----------|-----------|------|

---



**WE-EF LIGHTING USA, LLC**

410-D Keystone Drive, 15086 Warrendale, PA 15086 - Phone: +1 724 742 0030  
customersupport.usa@we-ef.com - <https://we-ef.com/us>

Subject to technical changes and errors. - Generated on 11/23/2024

**139-2400**

**FLC210 LED**

**we-ef**

**Optical Accessories**

**Linear spread lens**

---

| Description       | Part ID  | C1   |
|-------------------|----------|------|
| 10-180-FLC210-LED | 139-2404 | 3.94 |

---

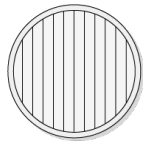

**WE-EF LIGHTING USA, LLC**

410-D Keystone Drive, 15086 Warrendale, PA 15086 - Phone: +1 724 742 0030  
customersupport.usa@we-ef.com - <https://we-ef.com/us>

Subject to technical changes and errors. - Generated on 11/23/2024

**139-2400**

**FLC210 LED**

**we-ef**

**Honeycomb louvre**

---

| Description   | Part ID  | C1   |
|---------------|----------|------|
| IW-FLC210-LED | 139-2405 | 3.94 |

---

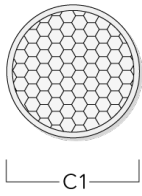

---

**Glare shield**

---

| Description   | Part ID  | A    | C1   |
|---------------|----------|------|------|
| ES-FLC210-LED | 139-2406 | 3.39 | 5.87 |

---

**WE-EF LIGHTING USA, LLC**

410-D Keystone Drive, 15086 Warrendale, PA 15086 - Phone: +1 724 742 0030

customersupport.usa@we-ef.com - <https://we-ef.com/us>

Subject to technical changes and errors. - Generated on 11/23/2024

**139-2400**

**FLC210 LED**

**we-ef**

**Snoot**

---

| Description   | Part ID  | A    | C1   |
|---------------|----------|------|------|
| ET-FLC210-LED | 139-2407 | 3.39 | 5.87 |

---

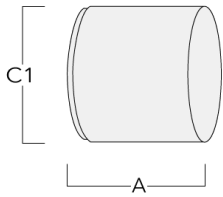

**WE-EF LIGHTING USA, LLC**

410-D Keystone Drive, 15086 Warrendale, PA 15086 - Phone: +1 724 742 0030  
customersupport.usa@we-ef.com - <https://we-ef.com/us>

Subject to technical changes and errors. - Generated on 11/23/2024