



### Beschreibung

Projektor [FP] zur konturgenauen Ausleuchtung polygoner Flächen. Sphärisches und asphärisches, zweifaches Plankonvexlinsensystem aus Glas zur Erzeugung eines parallelen Lichtbündels.

IP66, SKI. IK07. Korrosionsbeständiger Aluminiumguss. PCS beschichtete Edelstahlschrauben. 5CE Korrosionsschutz. CCG® Silikondichtung. Sicherheitsglas. Eine Kabelverschraubung, eine zweite Kabelverschraubung zur Durchverdrahtung auf Anfrage. PMMA LED Linse. Eingebaute LED Platine, austauschbar. Eingebaute elektronische Betriebsgeräte, thermisch getrennt.

|                    |  |
|--------------------|--|
| Gewicht            | 8.20 kg  |
| Lichtverteilung    | symmetrisch Framing-Projector [FP] - min. Öffnungswinkel |
| Lichtquelle        | LED-FT-24W / 700 mA - 2700 K                             |
| CRI                | 80   |
| Netz               | EVG  |
| LEDs               | 1  |
| Bemessungsleistung | 27 W   |

### Bemessungslichtstrom (lm)

|             |        |
|-------------|--------|
| LED Lumen   | 1541.9 |
| Total Lumen | 1541.9 |
| Ta          | 25     |

### Nominal Lichtstrom (lm)

|             |      |
|-------------|------|
| LED Lumen   | 3365 |
| Total Lumen | 3365 |
| Tc          | 25   |

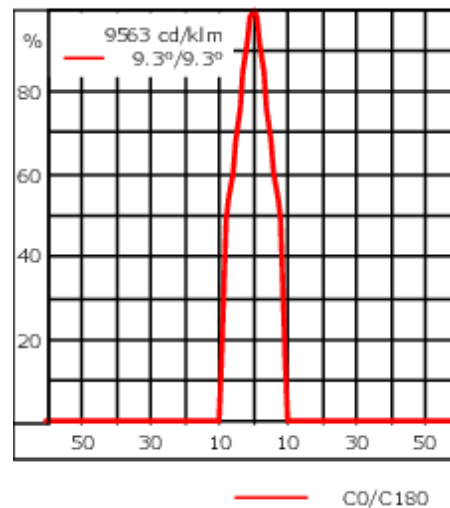
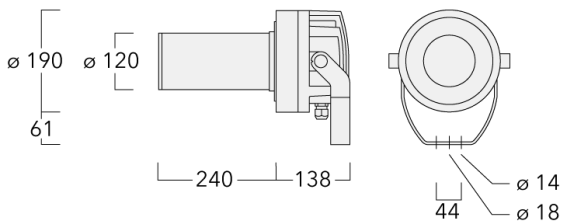

## Spezifikationen

### Materialbeschreibung

|                         |   |
|-------------------------|---|
| Gehäuse                 | Korrosionsbeständiger Aluminiumguss   |
| Abdeckung               | Sicherheitsglasscheibe  |
| Farben                  | <div style="display: flex; align-items: center;"> <div style="width: 20px; height: 10px; background-color: black; margin-right: 5px;"></div> <div>RAL9004 Signalschwarz</div> </div> <div style="display: flex; align-items: center; margin-top: 5px;"> <div style="width: 20px; height: 10px; background-color: #cccccc; margin-right: 5px;"></div> <div>RAL9006 Weißaluminium</div> </div> <div style="display: flex; align-items: center; margin-top: 5px;"> <div style="width: 20px; height: 10px; background-color: #808080; margin-right: 5px;"></div> <div>RAL9007 Graualuminium</div> </div> <div style="display: flex; align-items: center; margin-top: 5px;"> <div style="width: 20px; height: 10px; background-color: #333333; margin-right: 5px;"></div> <div>RAL7016 Anthrazitgrau</div> </div> <div style="display: flex; align-items: center; margin-top: 5px;"> <div style="width: 20px; height: 10px; background-color: #e0e0e0; margin-right: 5px;"></div> <div>RAL9016 Verkehrsweiß</div> </div> |
| Dichtung                | CCG_R_Silikondichtung   |
| Schrauben               | PCS beschichtete Edelstahlschrauben   |
| Schutzart               | IP66  |
| Schlagfestigkeit        | IK07  |
| Korrosionsbeständigkeit | 5CE   |
| Windangriffsfläche      | 0.06 m <sup>2</sup>   |

### Elektrische Beschreibung

|                               |   |
|-------------------------------|---|
| Netz                          | 220-240V / 50-60 Hz   |
| Netzgerät /<br>Vorschaltgerät | Standard. Variante mit DALI erhältlich, bei Bestellung bitte angeben. |
| Leistungsfaktor               | > 0.9   |
| Überspannungsschutz           | 6/6 kV (optional SP10)  |

#### WE-EF LEUCHTEN GmbH

Töpinger Straße 16, 29646 Bispingen, Germany - Tel: +49 5194 909-0

info.germany@we-ef.com - <https://we-ef.com/de>

Technische Änderungen und Irrtümer vorbehalten. - Erstellt am 23.11.2024

**139-2510\_min**

**FLC220 LED [FP]**

**we-ef**

### **Weitere Informationen**

---

Lebensdauer Ta=25° L70B50 > 50000h

Energieeffizienzklasse F (Lichtquelle)

---

**WE-EF LEUCHTEN GmbH**

Töpinger Straße 16, 29646 Bispingen, Germany - Tel: +49 5194 909-0

info.germany@we-ef.com - <https://we-ef.com/de>

Technische Änderungen und Irrtümer vorbehalten. - Erstellt am 23.11.2024

## Montagezubehör

## Montagesockel EM

| Beschreibung | Artikelnummer | D1  | D2  | H1  | M1 | Gewicht (kg) |
|--------------|---------------|-----|-----|-----|----|--------------|
| EM1-M16      | 270-9038      | 160 | 130 | 200 | 9  | 2            |



## Mastaufsatztraverse TA

| Beschreibung                                   | Artikelnummer | A | C1  | D x L1    | Gewicht (kg) | D x S     |
|--|---------------|---|-----|-----------|--------------|-----------|
| TA1 Mastaufsatztraverse, einfach (Ø 108 x 200) | 147-0096      |   | 130 | 108 x 200 | 7.50         | 108 x 200 |

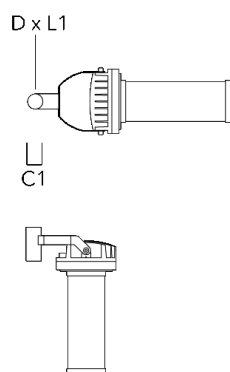

| Beschreibung                                    | Artikelnummer | A | C1  | D x L1    | Gewicht (kg) | D x S     |
|---|---------------|---|-----|-----------|--------------|-----------|
| TA2 Mastaufsatztraverse, zweifach (Ø 108 x 200) | 147-0097      |   | 130 | 108 x 200 | 7.50         | 108 x 200 |

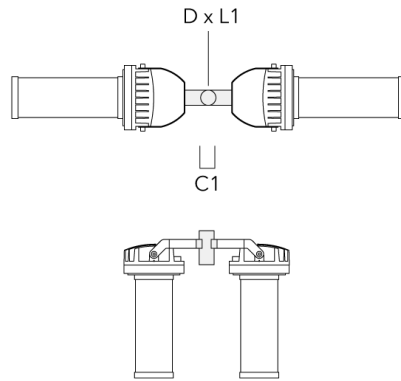

|  |          |      |     |          |       |          |
|--|----------|------|-----|----------|-------|----------|
| TA2-L Mastaufsatztraverse, zweifach (Ø 76 x 200) | 147-0105 | ±90° | 420 | 76 x 200 | 16.10 | 76 x 200 |
|--|----------|------|-----|----------|-------|----------|

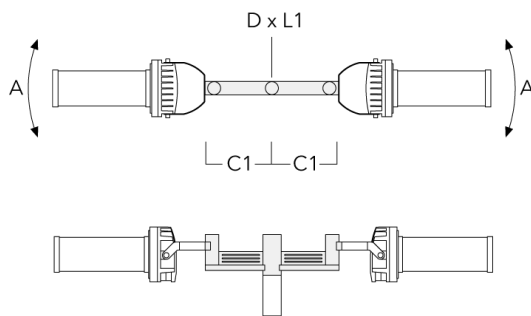

| Beschreibung                                   | Artikelnummer | A    | C1  | D x L1   | Gewicht (kg) | D x S    |
|--|---------------|------|-----|----------|--------------|----------|
| TA3 Mastaufsatztraverse, dreifach (Ø 89 x 200) | 147-0025      | ±90° | 650 | 89 x 200 | 17.90        | 89 x 200 |



|   |          |      |     |           |       |           |
|---|----------|------|-----|-----------|-------|-----------|
| TA3 Mastaufsatztraverse, dreifach (Ø 108 x 200) | 147-0098 | ±90° | 650 | 108 x 200 | 24.20 | 108 x 200 |
|---|----------|------|-----|-----------|-------|-----------|



| Beschreibung                                   | Artikelnummer | A    | C1  | D x L1   | Gewicht (kg) | D x S    |
|--|---------------|------|-----|----------|--------------|----------|
| TA4 Mastaufsatztraverse, vierfach (Ø 89 x 200) | 147-0099      | ±90° | 650 | 89 x 200 | 20.80        | 89 x 200 |



|   |          |      |     |           |       |           |
|---|----------|------|-----|-----------|-------|-----------|
| TA4 Mastaufsatztraverse, vierfach (Ø 108 x 200) | 147-0100 | ±90° | 650 | 108 x 200 | 24.20 | 108 x 200 |
|---|----------|------|-----|-----------|-------|-----------|



**Mastschelle TS**

| Beschreibung                               | Artikelnummer | D1      | Gewicht (kg) | D       |
|--|---------------|---------|--------------|---------|
| TS1-2/M12 Mastschelle, einfach (Ø 102-114) | 147-0526      | 102-114 | 1.50         | 102-114 |

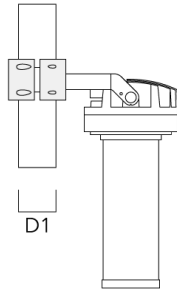
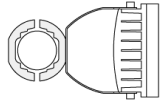

|  |          |         |      |         |
|--|----------|---------|------|---------|
| TS1-2/M12 Mastschelle, einfach (Ø 114-133) | 147-0544 | 114-133 | 1.70 | 114-133 |
|--|----------|---------|------|---------|

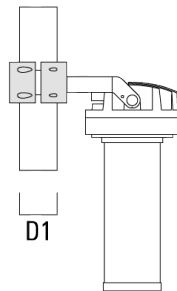
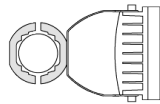



| Beschreibung                                | Artikelnummer | D1      | Gewicht (kg) | D       |
|---|---------------|---------|--------------|---------|
| TS2-2/M12 Mastschelle, zweifach (Ø 102-114) | 147-0527      | 102-114 | 1.50         | 102-114 |

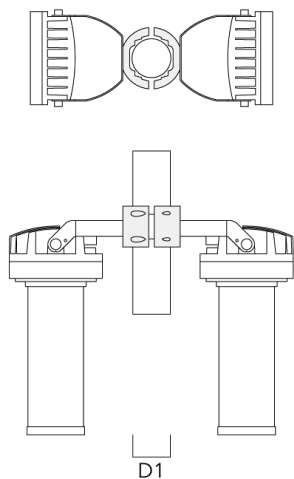

|   |          |       |      |       |
|---|----------|-------|------|-------|
| TS2-2/M12 Mastschelle, zweifach (Ø 76-89) | 147-0545 | 76-89 | 1.40 | 76-89 |
|---|----------|-------|------|-------|

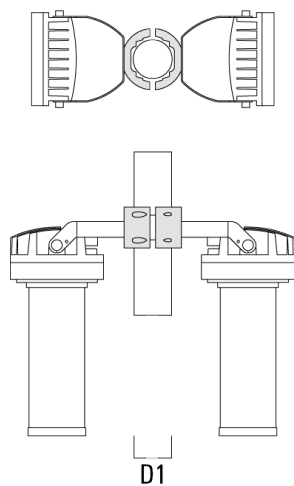

| Beschreibung                                | Artikelnummer | D1      | Gewicht (kg) | D       |
|---|---------------|---------|--------------|---------|
| TS2-2/M12 Mastschelle, zweifach (Ø 114-133) | 147-0546      | 114-133 | 1.60         | 114-133 |

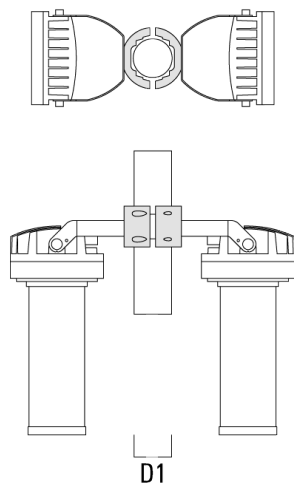

|  |          |       |      |       |
|--|----------|-------|------|-------|
| TS1-2/M12 Mastschelle, einfach (Ø 76-89) | 147-0543 | 76-89 | 1.40 | 76-89 |
|--|----------|-------|------|-------|

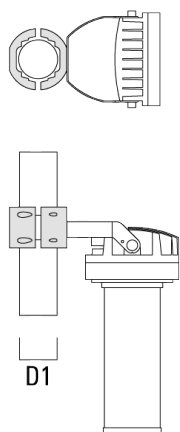

**Mastschelle PC**

| Beschreibung                                | Artikelnummer | D1    | Gewicht (kg) |
|---|---------------|-------|--------------|
| PC1 76-89/60 Mastschelle, einfach (Ø 76-89) | 139-2702      | 76-89 | 1.00         |

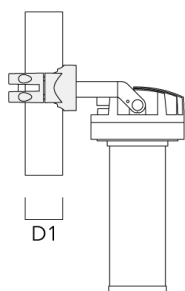
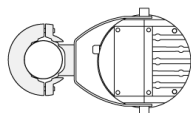

|  |          |       |      |
|--|----------|-------|------|
| PC2 76-89/60 Mastschelle, zweifach (Ø 76-89) | 139-2703 | 76-89 | 1.00 |
|--|----------|-------|------|

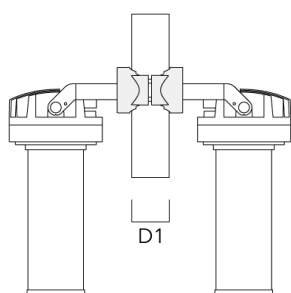
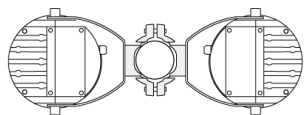

## FLC220 LED [FP]

| Beschreibung                                     | Artikelnummer | D1     | Gewicht (kg) |
|--|---------------|--------|--------------|
| PC1 82-109/60 Mastschelle, einfach<br>(Ø 82-109) | 139-2704      | 82-109 | 1.10         |



|   |          |        |      |
|---|----------|--------|------|
| PC2 82-109/60 Mastschelle, zweifach<br>(Ø 82-109) | 139-2705 | 82-109 | 1.10 |
|---|----------|--------|------|



| Beschreibung                                       | Artikelnummer | D1      | Gewicht (kg) |
|--|---------------|---------|--------------|
| PC1 102-114/60 Mastschelle, einfach<br>(Ø 102-114) | 139-2706      | 102-114 | 1.20         |

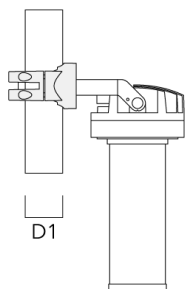
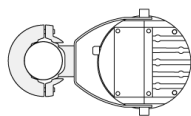

|   |          |         |      |
|---|----------|---------|------|
| PC2 102-114/60 Mastschelle,<br>zweifach (Ø 102-114) | 139-2707 | 102-114 | 1.20 |
|---|----------|---------|------|

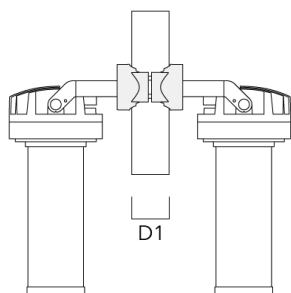
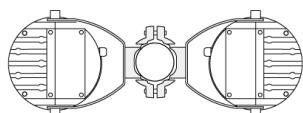

## FLC220 LED [FP]

| Beschreibung                                       | Artikelnummer | D1      | Gewicht (kg) |
|--|---------------|---------|--------------|
| PC1 114-133/60 Mastschelle, einfach<br>(Ø 144-133) | 139-2708      | 114-133 | 1.40         |

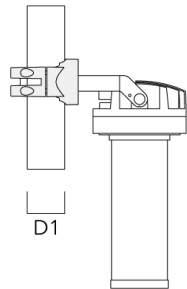
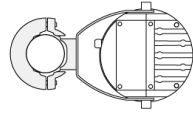

|   |          |         |      |
|---|----------|---------|------|
| PC2 114-133/60 Mastschelle,<br>zweifach (Ø 114-133) | 139-2709 | 114-133 | 1.40 |
|---|----------|---------|------|

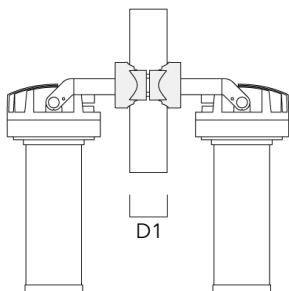

**139-2510\_min**

**FLC220 LED [FP]**

**we-ef**

## **Steuerung**

### **R2C Ready to Connect**

| Beschreibung                | Artikelnummer |
|-----------------------------|---------------|
| R2C Ready to Connect (oben) | 430-0019      |

#### **WE-EF LEUCHTEN GmbH**

Töpinger Straße 16, 29646 Bispingen, Germany - Tel: +49 5194 909-0

info.germany@we-ef.com - <https://we-ef.com/de>

Technische Änderungen und Irrtümer vorbehalten. - Erstellt am 23.11.2024