



### Description

RGBW/RGBA Colour Changer. IP66, Class I. Class II on request. IK07. Marine-grade, die-cast aluminium alloy. 5CE superior corrosion protection including PCS hardware. Silicone CCG® Controlled Compression Gasket. Safety glass lens. One cable gland. Second gland for through-wiring on request. Integral EC electronic converter, thermally separated. CAD-optimised optics for superior illumination and glare control. OLC® One LED Concept. Factory-installed LED circuit board with WE-EF Colour Boost Technology. With Colour Boost the targeted and selective control of individual channels or colours means that a higher power of the LEDs can be accessed than in total when all colours are simultaneously operated. The light output is thus maximized by targeted control of individual channels/colours.

DMX interface. For the M20 cable gland for network- and DMX-connection, WE-EF recommends a multi-core cable for DMX and power, "Power PUR-SR 3x1,5 + DMX".

Weight	13.80 kg
Light distribution	symmetric, very narrow beam, sharp cut-off [EES]
Light source	LED-4x12/84W - RGBA
CRI	20
Power supply	EC
LEDs	12
Rated input power	94 W
<b>Nominal Lumen (lm)</b>	
LED Lumen	375
Total Lumen	4500
Tj	85
<b>Rated lumens (lm)</b>	
LED Lumen	324.9
Total Lumen	3898.9
Ta	25

139-2426



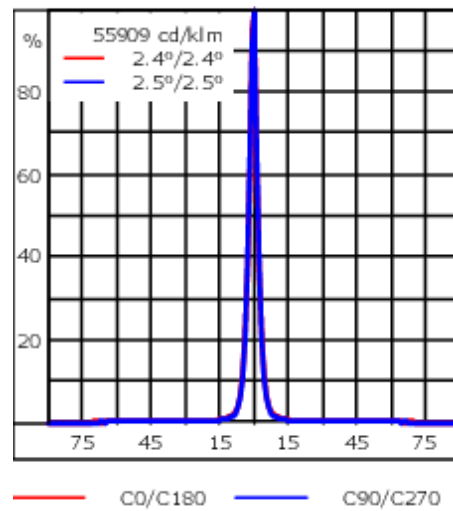
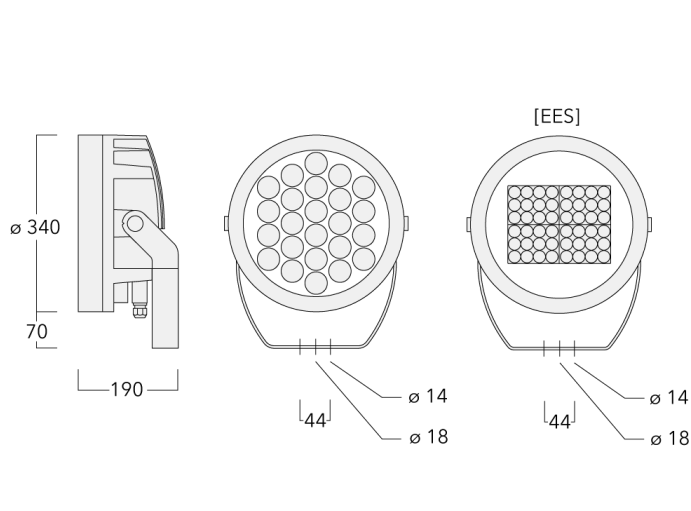

FLC240-CC LED

we-ef



## Specifications

### Material description

Body	Marine-grade, die-cast aluminium alloy
Lens	Safety glass lens
Colours	<ul style="list-style-type: none"><li> RAL9004 Signal black</li><li> RAL9006 White aluminium</li><li> RAL9007 Grey aluminium</li><li> RAL7016 Anthracite grey</li><li> RAL9016 Traffic white</li></ul>
Gasket	Silicone CCG® Controlled Compression Gasket
Fasteners	PCS Polymer Coated Stainless Steel Hardware
Ingress protection	IP66
Impact resistance	IK07
Corrosion resistance	5CE
Windage	0.090 m <sup>2</sup>

### Electrical description

Power supply	220-240V / 50-60 Hz
Driver / Ballast	DMX
Power factor	> 0.9
Surge protection	1/2 kV (optional SP10)

### Additional information

Lifetime	Ta=25° L90B10 > 90000h
----------	------------------------

#### WE-EF LEUCHTEN GmbH

Töpinger Straße 16, 29646 Bispingen, Germany - Phone: +49 5194 909-0

info@we-ef.com - <https://we-ef.com>

Subject to technical changes and errors. - Generated on 10/03/2025

## Mounting Accessories

### Floodlight mounting bracket TA

Description	Part ID	A	C1	D × L1	Weight (kg)	D × S
TA1 Mounting bracket, single* (Ø 76 x 200)	147-0023		130	76 x 200	1.90	76 x 200

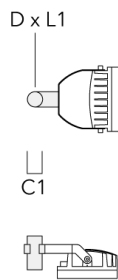

TA2 Mounting bracket, double* (Ø 76 x 200)	147-0024		130	76 x 200	1.90	76 x 200
--	----------	--	-----	----------	------	----------

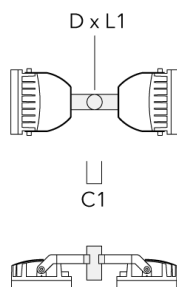

**FLC240-CC LED**

Description	Part ID	A	C1	D x L1	Weight (kg)	D x S
TA2-L Mounting bracket, double (Ø 76 x 200)	147-0105	±90°	420	76 x 200	16.10	76 x 200

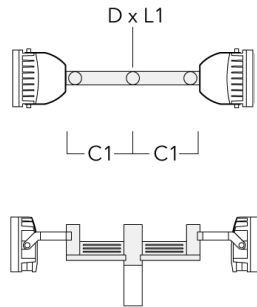

TA3 Mounting bracket, triple (Ø 89 x 200)	147-0025	±90°	650	89 x 200	17.90	89 x 200
---	----------	------	-----	----------	-------	----------

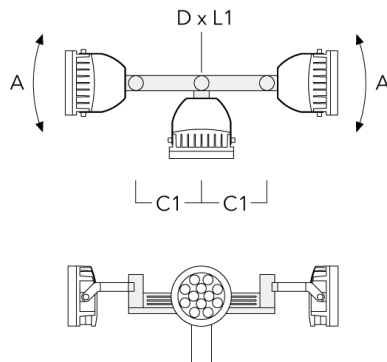

**FLC240-CC LED**

Description	Part ID	A	C1	D x L1	Weight (kg)	D x S
TA4 Mounting bracket, quad (Ø 89 x 200)	147-0099	±90°	650	89 x 200	20.80	89 x 200



TA1 Mounting bracket, single (Ø 108 x 200)	147-0096		130	108 x 200	7.50	108 x 200
--	----------	--	-----	-----------	------	-----------

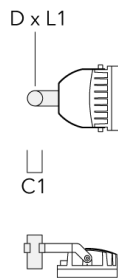

**FLC240-CC LED**

Description	Part ID	A	C1	D × L1	Weight (kg)	D × S
TA2 Mounting bracket, double (Ø 108 x 200)	147-0097		130	108 x 200	7.50	108 x 200



TA2-L Mounting bracket, double (Ø 108 x 200)	147-0148	±90°	420	108 x 200	20.20	108 x 200
--	----------	------	-----	-----------	-------	-----------

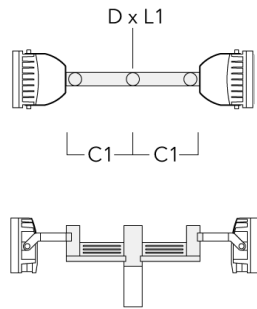

**FLC240-CC LED**

Description	Part ID	A	C1	D x L1	Weight (kg)	D x S
TA3 Mounting bracket, triple (Ø 108 x 200)	147-0098	±90°	650	108 x 200	24.20	108 x 200



TA4 Mounting bracket, quad (Ø 108 x 200)	147-0100	±90°	650	108 x 200	24.20	108 x 200
--	----------	------	-----	-----------	-------	-----------



**Pole clamp TS**

Description	Part ID	D1	Weight (kg)	D
TS1-2/M12 Pole clamp, single (Ø 76-89)	147-0543	76-89	1.40	76-89

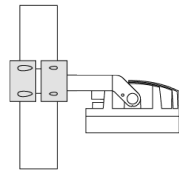
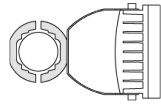

D1

TS1-2/M12 Pole clamp, single (Ø 102-114)	147-0526	102-114	1.50	102-114
--	----------	---------	------	---------

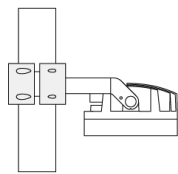
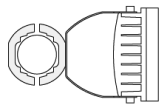

D1



139-2426

**we-ef**

**FLC240-CC LED**

---

Description	Part ID	D1	Weight (kg)	D
TS1-2/M12 Pole clamp, single (Ø 114-133)	147-0544	114-133	1.70	114-133

---

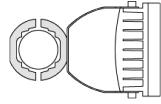

D1

---

TS2-2/M12 Pole clamp, double (Ø 76-89)	147-0545	76-89	1.40	76-89
--	----------	-------	------	-------

---

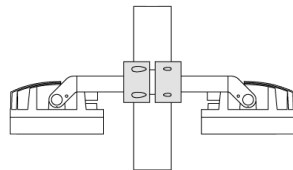
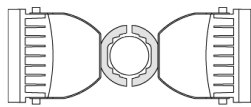

D1

**WE-EF LEUCHTEN GmbH**

Töpinger Straße 16, 29646 Bispingen, Germany - Phone: +49 5194 909-0  
info@we-ef.com - <https://we-ef.com>

Subject to technical changes and errors. - Generated on 10/03/2025

**FLC240-CC LED**

Description	Part ID	D1	Weight (kg)	D
TS2-2/M12 Pole clamp, double (Ø 102-114)	147-0527	102-114	1.50	102-114

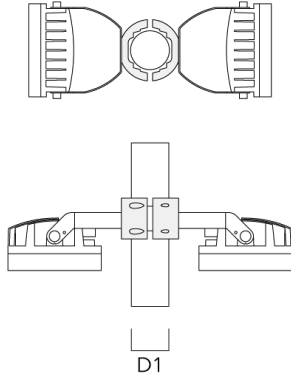

TS2-2/M12 Pole clamp, double (Ø 114-133)	147-0546	114-133	1.60	114-133
--	----------	---------	------	---------

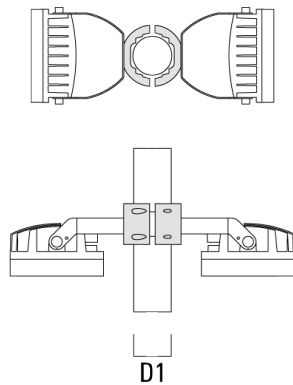

139-2426

FLC240-CC LED

**we-ef**

**Pole clamp PC**

Description	Part ID	D1	Weight (kg)
PC2 76-89/60 Pole clamp, double (Ø 76-89)	139-2703	76-89	1.00

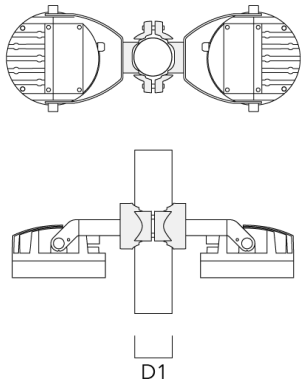

PC1 76-89/60 Pole clamp, single (Ø 76-89)	139-2702	76-89	1.00
---	----------	-------	------

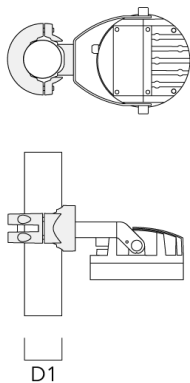

**WE-EF LEUCHTEN GmbH**

Töpinger Straße 16, 29646 Bispingen, Germany - Phone: +49 5194 909-0  
info@we-ef.com - <https://we-ef.com>

Subject to technical changes and errors. - Generated on 10/03/2025

139-2426

FLC240-CC LED

**we-ef**

---

Description	Part ID	D1	Weight (kg)
PC2 102-114/60 Pole clamp, double (Ø 102-114)	139-2707	102-114	1.20

---



---

PC1 102-114/60 Pole clamp, single (Ø 102-114)	139-2706	102-114	1.20
--	----------	---------	------

---



**WE-EF LEUCHTEN GmbH**

Töpinger Straße 16, 29646 Bispingen, Germany - Phone: +49 5194 909-0  
info@we-ef.com - <https://we-ef.com>

Subject to technical changes and errors. - Generated on 10/03/2025

139-2426

FLC240-CC LED

**we-ef**

---

Description	Part ID	D1	Weight (kg)
PC2 114-133/60 Pole clamp, double (Ø 114-133)	139-2709	114-133	1.40

---



---

PC1 114-133/60 Pole clamp, single (Ø 114-133)	139-2708	114-133	1.40
--	----------	---------	------

---



139-2426

**we-ef**

**FLC240-CC LED**

---

Description	Part ID	D1	Weight (kg)
PC2 82-109/60 Pole camp, double (Ø 82-109)	139-2705	82-109	1.10

---



---

PC1 82-109/60 Pole camp, single (Ø 82-109)	139-2704	82-109	1.10
--	----------	--------	------

---



**WE-EF LEUCHTEN GmbH**

Töpinger Straße 16, 29646 Bispingen, Germany - Phone: +49 5194 909-0  
info@we-ef.com - <https://we-ef.com>

Subject to technical changes and errors. - Generated on 10/03/2025

## Optical Accessories

### Wallwash lens

Description	Part ID	Additional information	C1
IO-20-FLC240-LED	139-1854	for symmetric [M] medium beam luminaire only	289

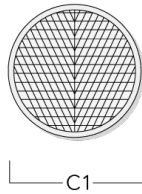

### Linear spread lens

Description	Part ID	C1
Linear spread lens IO-180	139-1855	289

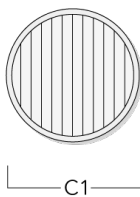

**Snoot**

Description	Part ID	A	C1
ET-FLC240-LED	139-1859	200	346

**Glare shield**

Description	Part ID	A	C1
ES-FLC240-LED	139-1858	200	346





**Flood lens**

---

Description	Part ID	C1
IO-360-FLC240-LED	139-1856	289

---



---

**Honeycomb louvre**

---

Description	Part ID	C1	H1
IW-FLC240-CC LED - [E][EE][EES]	139-1857	279	

---



**139-2426**

**FLC240-CC LED**

**we-ef**

---

Description	Part ID	C1	H1
IW-FLC24_EES-CC LED	139-2433	205	160

---

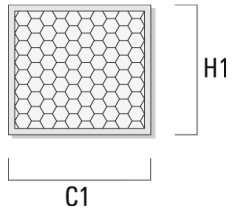

**WE-EF LEUCHTEN GmbH**

Töpinger Straße 16, 29646 Bispingen, Germany - Phone: +49 5194 909-0  
info@we-ef.com - <https://we-ef.com>

Subject to technical changes and errors. - Generated on 10/03/2025

139-2426

FLC240-CC LED

**we-ef**

## Control

### DMX Controller

Description	Part ID
DMX Controller	400-0469

### DMX Controller (smart)

Description	Part ID	Additional information
DMX Controller (smart)	400-0470	IP20. The Touch Panel is an intuitive and easy-to-use keypad or one DMX universe. It can store up to 36 scenes; alternatively, via ....



#### WE-EF LEUCHTEN GmbH

Töpinger Straße 16, 29646 Bispingen, Germany - Phone: +49 5194 909-0  
info@we-ef.com - <https://we-ef.com>

Subject to technical changes and errors. - Generated on 10/03/2025

139-2426

FLC240-CC LED

**we-ef**

### DMX Controller - RDM ready

---

Description	Part ID
DMX Controller - RDM ready	400-0471

---



---

### DMX Splitter

---

Description	Part ID
DMX Splitter	400-0473

---



---

#### WE-EF LEUCHTEN GmbH

Töpinger Straße 16, 29646 Bispingen, Germany - Phone: +49 5194 909-0  
info@we-ef.com - <https://we-ef.com>

Subject to technical changes and errors. - Generated on 10/03/2025

139-2426

FLC240-CC LED

**we-ef**

### DMX Booster Box

---

Description	Part ID
DMX Booster Box	400-0474

---



---

### DMX Motion Sensor

---

Description	Part ID
DMX Motion Sensor	400-0478

---



#### WE-EF LEUCHTEN GmbH

Töpinger Straße 16, 29646 Bispingen, Germany - Phone: +49 5194 909-0  
info@we-ef.com - <https://we-ef.com>

Subject to technical changes and errors. - Generated on 10/03/2025

**DMX Termination Plug**

---

Description	Part ID
DMX Termination Plug	400-0475

---



---

**DMX Plug and Socket**

---

Description	Part ID
DMX Plug and Socket	400-0479

---



**139-2426**

**FLC240-CC LED**

**we-ef**

**DMX Combination Cable**

---

Description	Part ID
DMX Combination Cable	400-0480

---



---

**DMX Wireless Repeater**

---

Description	Part ID
DMX Wireless Repeater	400-0477

---



---

**WE-EF LEUCHTEN GmbH**

Töpinger Straße 16, 29646 Bispingen, Germany - Phone: +49 5194 909-0  
info@we-ef.com - <https://we-ef.com>

Subject to technical changes and errors. - Generated on 10/03/2025

## FLC240-CC LED

## DMX Wireless Transceiver

Description	Part ID
DMX Wireless Transceiver	400-0476



## DMX Controller (smart) - RDM ready

Description	Part ID
DMX Controller (smart) - RDM ready	400-0472

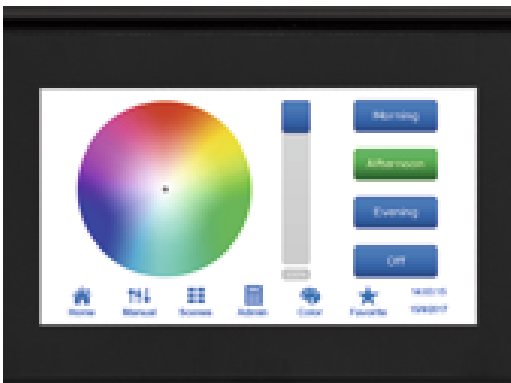

## R2C Ready to Connect

Description	Part ID
R2C Ready to Connect (top)	430-0019

## WE-EF LEUCHTEN GmbH

Töpinger Straße 16, 29646 Bispingen, Germany - Phone: +49 5194 909-0  
 info@we-ef.com - <https://we-ef.com>

Subject to technical changes and errors. - Generated on 10/03/2025



**139-2426**

**FLC240-CC LED**

**we-ef**

**DMX Wireless Antenna**

Description	Part ID
Antenna RF5dB	430-0036
Antenna RF1.8dB	430-0018

**WE-EF LEUCHTEN GmbH**

Töpinger Straße 16, 29646 Bispingen, Germany - Phone: +49 5194 909-0  
info@we-ef.com - <https://we-ef.com>

Subject to technical changes and errors. - Generated on 10/03/2025