

139-2430

FLC260-CC LED

we-ef



Description

RGBW/RGBA Colour Changer. IP66, Class I. Class II on request. IK07. Marine-grade, die-cast aluminium alloy. 5CE superior corrosion protection including PCS hardware. Silicone CCG® Controlled Compression Gasket. Safety glass lens. One cable gland. Second gland for through-wiring on request. Integral EC electronic converter, thermally separated. CAD-optimised optics for superior illumination and glare control. OLC® One LED Concept. Factory-installed LED circuit board with WE-EF Colour Boost Technology. With Colour Boost the targeted and selective control of individual channels or colours means that a higher power of the LEDs can be accessed than in total when all colours are simultaneously operated. The light output is thus maximized by targeted control of individual channels/colours.

DMX interface. For the M20 cable gland for network- and DMX-connection, WE-EF recommends a multi-core cable for DMX and power, "Power PUR-SR 3x1,5 + DMX".

Weight	18.00 kg
Light distribution	symmetric, very narrow beam, sharp cut-off [EES]
Light source	LED-4x18/126W - RGBA
CRI	20
Power supply	EC
LEDs	18
Rated input power	141 W
Nominal Lumen (lm)	
LED Lumen	375
Total Lumen	6750
Tj	85
Rated lumens (lm)	
LED Lumen	324.9
Total Lumen	5848.4
Ta	25

Fagerhult Lighting Ltd

33-34 Dolben Street, SE1 0UQ London, United Kingdom

<https://we-ef.com/uk>

Subject to technical changes and errors. - Generated on 10/03/2025

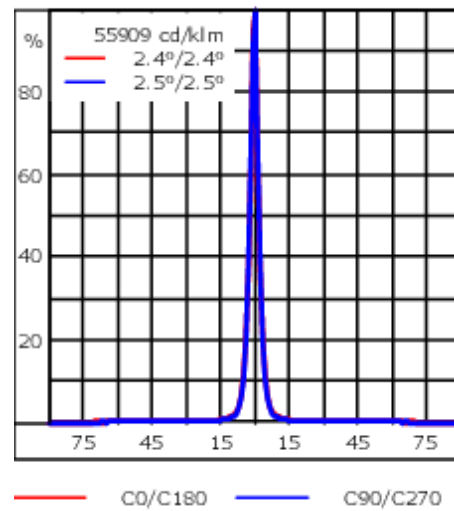
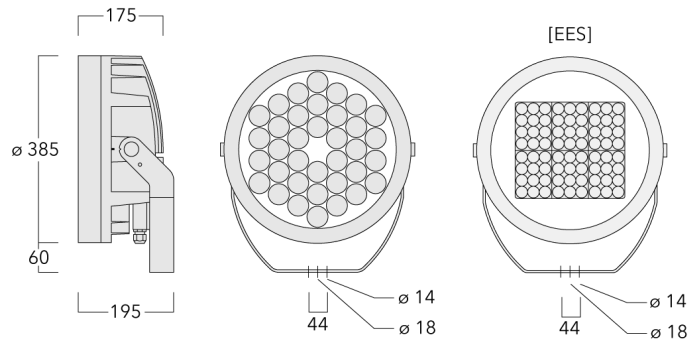
139-2430**FLC260-CC LED****we-ef**

Specifications

Material description

Body	Marine-grade, die-cast aluminium alloy
Lens	Safety glass lens
Colours	<ul style="list-style-type: none"> RAL9004 Signal black RAL9006 White aluminium RAL9007 Grey aluminium RAL7016 Anthracite grey RAL9016 Traffic white
Gasket	Silicone CCG® Controlled Compression Gasket
Fasteners	PCS Polymer Coated Stainless Steel Hardware
Ingress protection	IP66
Impact resistance	IK07
Corrosion resistance	5CE
Windage	0.116 m ²

Electrical description

Power supply	220-240V / 50-60 Hz
Driver / Ballast	DMX
Power factor	> 0.9
Surge protection	1/2 kV (optional SP10)

Additional information

Lifetime	Ta=25° L90B10 > 90000h
Energy efficiency class	G (Light source)

Fagerhult Lighting Ltd

33-34 Dolben Street, SE1 0UQ London, United Kingdom

<https://we-ef.com/uk>

Subject to technical changes and errors. - Generated on 10/03/2025

139-2430

FLC260-CC LED

we-ef

Optical Accessories

Flood lens

Description	Part ID	C1
IO-360-FLC260-LED	139-1862	332

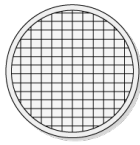

Honeycomb louvre

Description	Part ID	C1	H1
IW-03-FLC260-LED - [E][EE][EES]	139-1863	324	

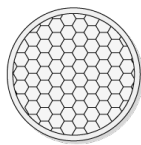

Fagerhult Lighting Ltd

33-34 Dolben Street, SE1 0UQ London, United Kingdom

<https://we-ef.com/uk>

Subject to technical changes and errors. - Generated on 10/03/2025

FLC260-CC LED

Description	Part ID	C1	H1
IW-FLC26_EES-CC LED	139-2434	232	209

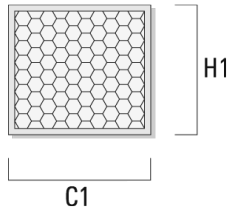

Linear spread lens

Description	Part ID	C1
IO-180-FLC260-CC LED	139-1861	332



139-2430

FLC260-CC LED

we-ef

Wallwash lens

Description	Part ID	C1
IO-20-FLC260-CC LED	139-1860	332



Snoot

Description	Part ID	A	C1
ET-FLC260-LED	139-1865	222	393

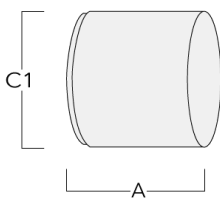

Fagerhult Lighting Ltd

33-34 Dolben Street, SE1 0UQ London, United Kingdom

<https://we-ef.com/uk>

Subject to technical changes and errors. - Generated on 10/03/2025

139-2430

FLC260-CC LED

we-ef

Glare shield

Description	Part ID	A	C1
ES-FLC260-LED	139-1864	222	393



Mounting Accessories

Pole clamp TS

Description	Part ID	D1	Weight (kg)	D
TS1-2/M12 Pole clamp, single (Ø 76-89)	147-0543	76-89	1.40	76-89

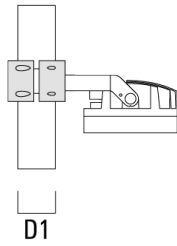
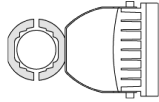

TS1-2/M12 Pole clamp, single (Ø 114-133)	147-0544	114-133	1.70	114-133
--	----------	---------	------	---------

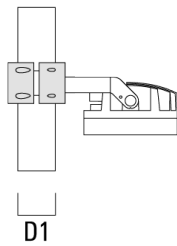
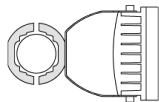

FLC260-CC LED

Description	Part ID	D1	Weight (kg)	D
TS2-2/M12 Pole clamp, double (Ø 76-89)	147-0545	76-89	1.40	76-89

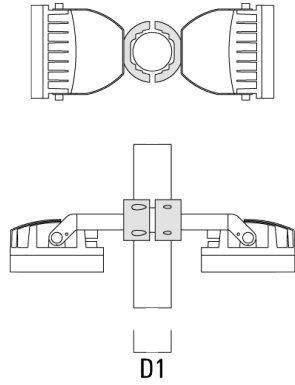

TS2-2/M12 Pole clamp, double (Ø 114-133)	147-0546	114-133	1.60	114-133
--	----------	---------	------	---------

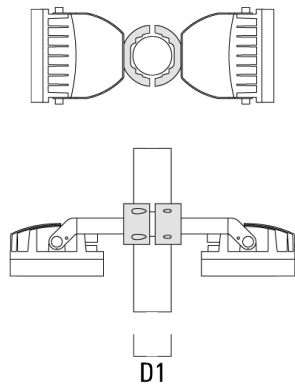

139-2430

FLC260-CC LED

we-ef

Floodlight mounting bracket TA

Description	Part ID	C1	D × L1	Weight (kg)	D × S
TA1 Mounting bracket, single* (Ø 76 x 200)	147-0023	130	76 x 200	1.90	76 x 200

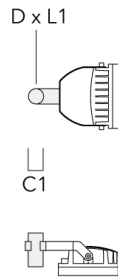

Pole clamp PC

Description	Part ID	D1	Weight (kg)
PC2 76-89/60 Pole clamp, double (Ø 76-89)	139-2703	76-89	1.00

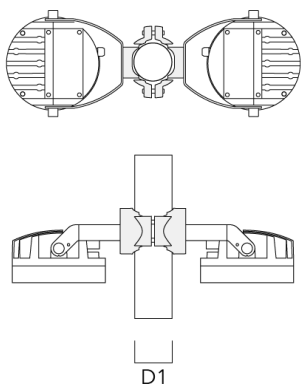

Fagerhult Lighting Ltd

33-34 Dolben Street, SE1 0UQ London, United Kingdom

<https://we-ef.com/uk>

Subject to technical changes and errors. - Generated on 10/03/2025

FLC260-CC LED

Description	Part ID	D1	Weight (kg)
PC1 76-89/60 Pole clamp, single (Ø 76-89)	139-2702	76-89	1.00

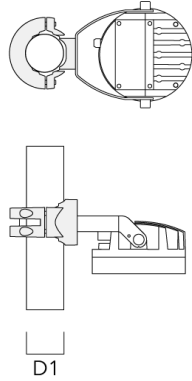

PC2 102-114/60 Pole clamp, double (Ø 102-114)	139-2707	102-114	1.20
---	----------	---------	------

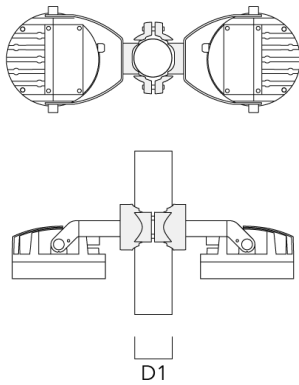

FLC260-CC LED

Description	Part ID	D1	Weight (kg)
PC1 102-114/60 Pole clamp, single (Ø 102-114)	139-2706	102-114	1.20



PC2 114-133/60 Pole clamp, double (Ø 114-133)	139-2709	114-133	1.40
--	----------	---------	------



FLC260-CC LED

Description	Part ID	D1	Weight (kg)
PC1 114-133/60 Pole clamp, single (Ø 114-133)	139-2708	114-133	1.40



PC2 82-109/60 Pole camp, double (Ø 82-109)	139-2705	82-109	1.10
--	----------	--------	------

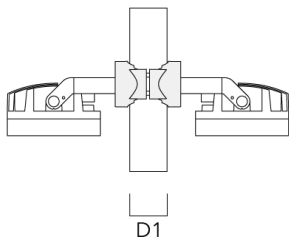

139-2430

FLC260-CC LED

we-ef

Description	Part ID	D1	Weight (kg)
PC1 82-109/60 Pole camp, single (Ø 82-109)	139-2704	82-109	1.10



D1

Fagerhult Lighting Ltd

33-34 Dolben Street, SE1 0UQ London, United Kingdom

<https://we-ef.com/uk>

Subject to technical changes and errors. - Generated on 10/03/2025

139-2430

FLC260-CC LED

we-ef

Control

DMX Controller

Description	Part ID
DMX Controller	400-0469

DMX Controller (smart)

Description	Part ID	Additional information
DMX Controller (smart)	400-0470	IP20. The Touch Panel is an intuitive and easy-to-use keypad or one DMX universe. It can store up to 36 scenes; alternatively, via



139-2430

FLC260-CC LED

we-ef

DMX Controller - RDM ready

Description	Part ID
DMX Controller - RDM ready	400-0471



DMX Splitter

Description	Part ID
DMX Splitter	400-0473



Fagerhult Lighting Ltd

33-34 Dolben Street, SE1 0UQ London, United Kingdom

<https://we-ef.com/uk>

Subject to technical changes and errors. - Generated on 10/03/2025

139-2430

FLC260-CC LED

we-ef

DMX Booster Box

Description	Part ID
DMX Booster Box	400-0474



DMX Motion Sensor

Description	Part ID
DMX Motion Sensor	400-0478



Fagerhult Lighting Ltd

33-34 Dolben Street, SE1 0UQ London, United Kingdom

<https://we-ef.com/uk>

Subject to technical changes and errors. - Generated on 10/03/2025

139-2430

FLC260-CC LED

we-ef

DMX Termination Plug

Description	Part ID
DMX Termination Plug	400-0475



DMX Plug and Socket

Description	Part ID
DMX Plug and Socket	400-0479



Fagerhult Lighting Ltd

33-34 Dolben Street, SE1 0UQ London, United Kingdom

<https://we-ef.com/uk>

Subject to technical changes and errors. - Generated on 10/03/2025

139-2430

FLC260-CC LED

we-ef

DMX Combination Cable

Description	Part ID
DMX Combination Cable	400-0480



DMX Wireless Repeater

Description	Part ID
DMX Wireless Repeater	400-0477



Fagerhult Lighting Ltd

33-34 Dolben Street, SE1 0UQ London, United Kingdom

<https://we-ef.com/uk>

Subject to technical changes and errors. - Generated on 10/03/2025

DMX Wireless Transceiver

Description	Part ID
DMX Wireless Transceiver	400-0476

**DMX Controller (smart) - RDM ready**

Description	Part ID
DMX Controller (smart) - RDM ready	400-0472

**DMX Wireless Antenna**

Description	Part ID
Antenna RF5dB	430-0036

Fagerhult Lighting Ltd

33-34 Dolben Street, SE1 0UQ London, United Kingdom

<https://we-ef.com/uk>

Subject to technical changes and errors. - Generated on 10/03/2025

139-2430

FLC260-CC LED

we-ef

Description	Part ID
Antenna RF1.8dB	430-0018

Fagerhult Lighting Ltd

33-34 Dolben Street, SE1 0UQ London, United Kingdom

<https://we-ef.com/uk>

Subject to technical changes and errors. - Generated on 10/03/2025