

139-2431

FLC260-TW LED

we-ef



Description

Tunable White. IP66, Class I. Class II on request. IK07. Marine-grade, die-cast aluminium alloy. 5CE superior corrosion protection including PCS hardware. Silicone CCG® Controlled Compression Gasket. Safety glass lens. One cable gland. Second gland for through-wiring on request. Integral EC electronic converter, thermally separated. CAD-optimised optics for superior illumination and glare control. OLC® One LED Concept. Factory-installed LED circuit board with Tunable White Technology. DALI Interface.

Weight	18.50 kg
Light distribution	symmetric, very narrow beam, sharp cut-off [EES]
Light source	LED-72/72W - 2700-6000K
CRI	80
Power supply	EC
LEDs	72
Rated input power	79 W
Nominal Lumen (lm)	
LED Lumen	95
Total Lumen	6840
Tj	85
Rated lumens (lm)	
LED Lumen	88.7
Total Lumen	6386.9
Ta	25

Fagerhult Lighting Ltd

33-34 Dolben Street, SE1 0UQ London, United Kingdom

<https://we-ef.com/uk>

Subject to technical changes and errors. - Generated on 23/11/2024

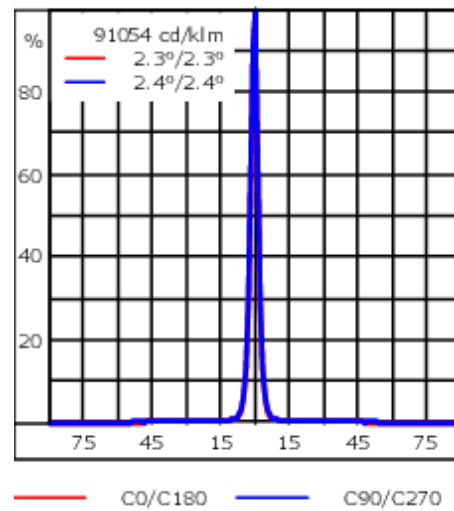
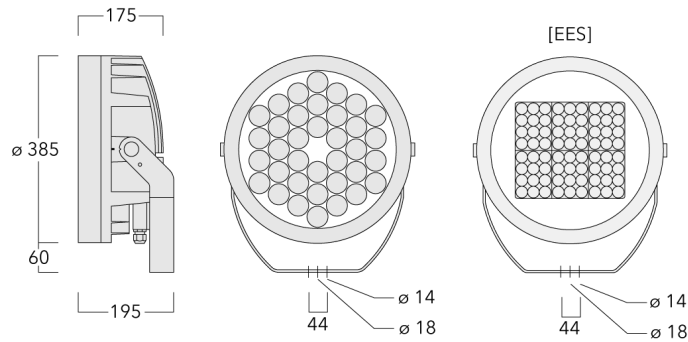
139-2431**FLC260-TW LED****we-ef**

Specifications

Material description

Body	Marine-grade, die-cast aluminium alloy
Lens	Safety glass lens
Colours	<div style="display: flex; flex-direction: column; gap: 5px;"> <div> RAL9004 Signal black</div> <div> RAL9006 White aluminium</div> <div> RAL9007 Grey aluminium</div> <div> RAL7016 Anthracite grey</div> <div> RAL9016 Traffic white</div> </div>
Gasket	Silicone CCG® Controlled Compression Gasket
Fasteners	PCS Polymer Coated Stainless Steel Hardware
Ingress protection	IP66
Impact resistance	IK07
Corrosion resistance	5CE
Windage	0.116 m ²

Electrical description

Power supply	220-240V / 50-60 Hz
Driver / Ballast	DALI
Power factor	> 0.9
Surge protection	1/2 kV (optional SP10)

Additional information

Lifetime	Ta=25° L90B10 > 90000h
Energy efficiency class	E (Light source)

Fagerhult Lighting Ltd

33-34 Dolben Street, SE1 0UQ London, United Kingdom

<https://we-ef.com/uk>

Subject to technical changes and errors. - Generated on 23/11/2024

139-2431

FLC260-TW LED

we-ef

Optical Accessories

Wallwash lens

Description	Part ID	C1
IO-20-FLC260-LED	139-1860	332

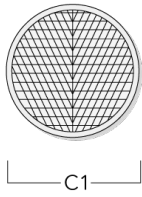

Linear spread lens

Description	Part ID	C1
IO-180-FLC260-LED	139-1861	332



Fagerhult Lighting Ltd

33-34 Dolben Street, SE1 0UQ London, United Kingdom

<https://we-ef.com/uk>

Subject to technical changes and errors. - Generated on 23/11/2024

139-2431

FLC260-TW LED

we-ef

Snoot

Description	Part ID	A	C1
ET-FLC260-LED	139-1865	222	393

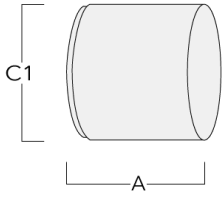

Glare shield

Description	Part ID	A	C1
ES-FLC260-LED	139-1864	222	393

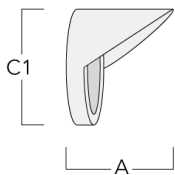

Mounting Accessories

Pole clamp TS

Description	Part ID	D1	Weight (kg)	D
TS1-2/M12 Pole clamp, single (Ø 114-133)	147-0544	114-133	1.70	114-133

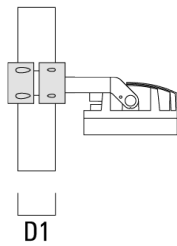
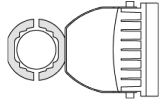

TS2-2/M12 Pole clamp, double (Ø 76-89)	147-0545	76-89	1.40	76-89
--	----------	-------	------	-------

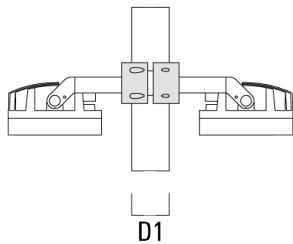
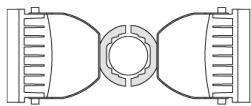

Floodlight mounting bracket TA

Description	Part ID	C1	D × L1	Weight (kg)	D × S
TA1 Mounting bracket, single* (Ø 76 x 200)	147-0023	130	76 x 200	1.90	76 x 200

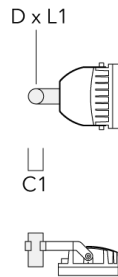

Pole clamp PC

Description	Part ID	D1	Weight (kg)
PC2 76-89/60 Pole clamp, double (Ø 76-89)	139-2703	76-89	1.00

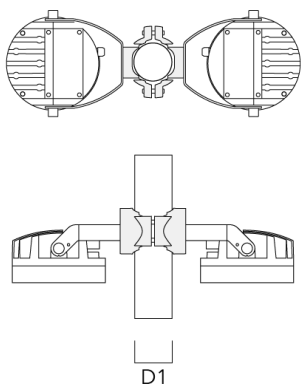

139-2431

we-ef

FLC260-TW LED

Description	Part ID	D1	Weight (kg)
PC1 76-89/60 Pole clamp, single (Ø 76-89)	139-2702	76-89	1.00

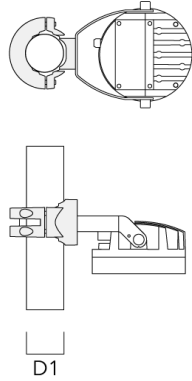

PC2 102-114/60 Pole clamp, double (Ø 102-114)	139-2707	102-114	1.20
---	----------	---------	------

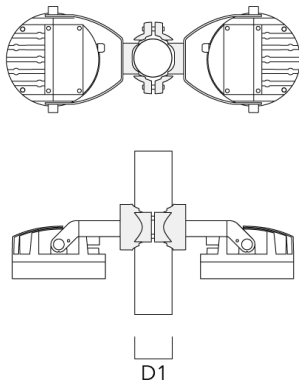

Fagerhult Lighting Ltd

33-34 Dolben Street, SE1 0UQ London, United Kingdom

<https://we-ef.com/uk>

Subject to technical changes and errors. - Generated on 23/11/2024

139-2431

we-ef

FLC260-TW LED

Description	Part ID	D1	Weight (kg)
PC1 102-114/60 Pole clamp, single (Ø 102-114)	139-2706	102-114	1.20

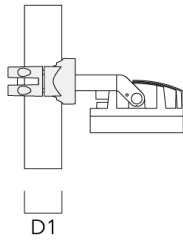
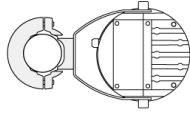

PC2 114-133/60 Pole clamp, double (Ø 114-133)	139-2709	114-133	1.40
--	----------	---------	------

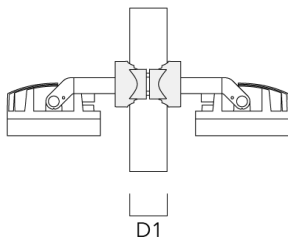
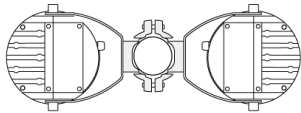

139-2431

we-ef

FLC260-TW LED

Description	Part ID	D1	Weight (kg)
PC1 114-133/60 Pole clamp, single (Ø 114-133)	139-2708	114-133	1.40

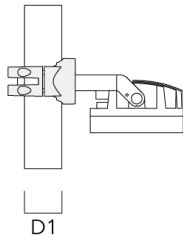
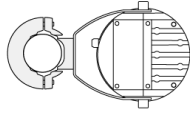

PC2 82-109/60 Pole camp, double (Ø 82-109)	139-2705	82-109	1.10
--	----------	--------	------

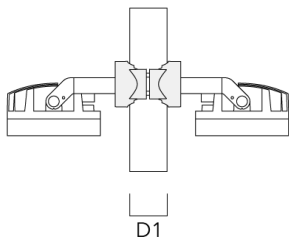
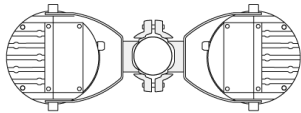

Fagerhult Lighting Ltd

33-34 Dolben Street, SE1 0UQ London, United Kingdom

<https://we-ef.com/uk>

Subject to technical changes and errors. - Generated on 23/11/2024

139-2431

FLC260-TW LED

we-ef

Control

DMX Wireless Repeater

Description	Part ID
DMX Wireless Repeater	400-0477



DMX Wireless Transceiver

Description	Part ID
DMX Wireless Transceiver	400-0476



Fagerhult Lighting Ltd

33-34 Dolben Street, SE1 0UQ London, United Kingdom

<https://we-ef.com/uk>

Subject to technical changes and errors. - Generated on 23/11/2024