



### Beschreibung

Projektor [GP] zur Projektion von Gobos auf Flächen. Sphärisches und asphärisches, zweifaches Plankonvexlinsensystem aus Glas zur Erzeugung eines parallelen Lichtbündels. Gobo Motive auf Anfrage, empfohlener Innendurchmesser 38 mm. Gobo muss separat bestellt werden.

IP66, SKI. IK07. Korrosionsbeständiger Aluminiumguss. PCS beschichtete Edelstahlschrauben. 5CE Korrosionsschutz. CCG® Silikondichtung. Sicherheitsglas. Eine Kabelverschraubung, eine zweite Kabelverschraubung zur Durchverdrahtung auf Anfrage. PMMA LED Linse. Eingebaute LED Platine, austauschbar. Eingebaute elektronische Betriebsgeräte, thermisch getrennt.

Gobo Außendurchmesser 66 mm, max. bedruckbare Fläche D = 48 mm. WE-EF Empfehlung D = 38 mm.

Gewicht	8.20 kg
Lichtverteilung	symmetrisch Gobo-Projector [GP] - max. Öffnungswinkel
Lichtquelle	LED-FT-37W / 1050 mA - 2700 K
CRI	80
Netz	EVG
LEDs	1
Bemessungsleistung	42 W

### Bemessungslichtstrom (lm)

LED Lumen	1343.5
Total Lumen	1343.5
Ta	25

### Nominal Lichtstrom (lm)

LED Lumen	4565
Total Lumen	4565
Tc	25

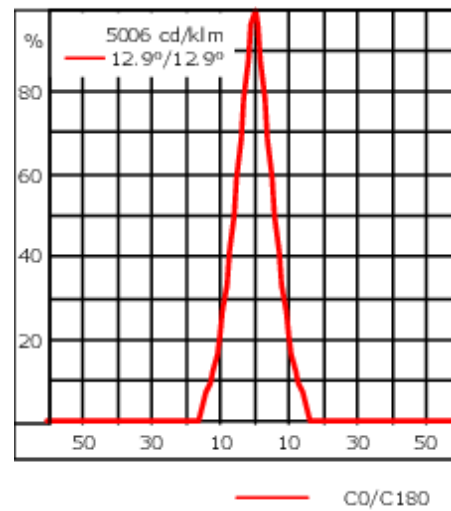

## Spezifikationen

### Materialbeschreibung

Gehäuse	Korrosionsbeständiger Aluminiumguss
Abdeckung	Sicherheitsglasscheibe
Farben	<div style="display: flex; align-items: center;"> <div style="width: 20px; height: 10px; background-color: black; margin-right: 5px;"></div> <span>RAL9004 Signalschwarz</span> </div> <div style="display: flex; align-items: center; margin-top: 5px;"> <div style="width: 20px; height: 10px; background-color: gray; margin-right: 5px;"></div> <span>RAL9007 Graualuminium</span> </div> <div style="display: flex; align-items: center; margin-top: 5px;"> <div style="width: 20px; height: 10px; background-color: darkgray; margin-right: 5px;"></div> <span>RAL7016 Anthrazitgrau</span> </div> <div style="display: flex; align-items: center; margin-top: 5px;"> <div style="width: 20px; height: 10px; background-color: lightgray; margin-right: 5px;"></div> <span>RAL9016 Verkehrsweiß</span> </div>
Dichtung	CCG® Silikondichtung
Schrauben	PCS beschichtete Edelstahlschrauben
Schutzart	IP66
Schlagfestigkeit	IK07
Korrosionsbeständigkeit	5CE
Windangriffsfläche	0.06 m <sup>2</sup>

### Elektrische Beschreibung

Netz	220-240V / 50-60 Hz
Netzgerät / Vorschaltgerät	Standard. Variante mit DALI erhältlich, bei Bestellung bitte angeben.
Leistungsfaktor	> 0.9

#### WE-EF Switzerland AG

Himmelrichstrasse 6, 6003 Luzern - Tel: +41 41 210 49 95

info.switzerland@we-ef.com - [https://we-ef.com/ch\\_de](https://we-ef.com/ch_de)

Technische Änderungen und Irrtümer vorbehalten. - Erstellt am 23.10.2024

**139-2512\_max**

**FLC220 LED [GP]**

**we-ef**

### **Weitere Informationen**

---

Lebensdauer Ta=25° L70B50 > 50000h

Energieeffizienzklasse F (Lichtquelle)

---

**WE-EF Switzerland AG**

Himmelrichstrasse 6, 6003 Luzern - Tel: +41 41 210 49 95

info.switzerland@we-ef.com - [https://we-ef.com/ch\\_de](https://we-ef.com/ch_de)

Technische Änderungen und Irrtümer vorbehalten. - Erstellt am 23.10.2024

## Montagezubehör

## Montagesockel EM

Beschreibung	Artikelnummer	D1	D2	H1	M1	Gewicht (kg)
EM1-M16	270-9038	160	130	200	9	2



## Mastaufsatztraverse TA

Beschreibung	Artikelnummer	A	C1	D x L1	Gewicht (kg)	D x S
TA1 Mastaufsatztraverse, einfach (Ø 108 x 200)	147-0096		130	108 x 200	7.50	108 x 200



**FLC220 LED [GP]**

Beschreibung	Artikelnummer	A	C1	D x L1	Gewicht (kg)	D x S
TA2 Mastaufsatztraverse, zweifach (Ø 108 x 200)	147-0097		130	108 x 200	7.50	108 x 200



TA2-L Mastaufsatztraverse, zweifach (Ø 76 x 200)	147-0105	±90°	420	76 x 200	16.10	76 x 200
--	----------	------	-----	----------	-------	----------

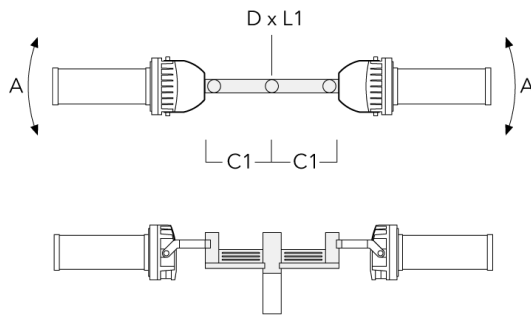

**FLC220 LED [GP]**

Beschreibung	Artikelnummer	A	C1	D x L1	Gewicht (kg)	D x S
TA3 Mastaufsatztraverse, dreifach (Ø 89 x 200)	147-0025	±90°	650	89 x 200	17.90	89 x 200

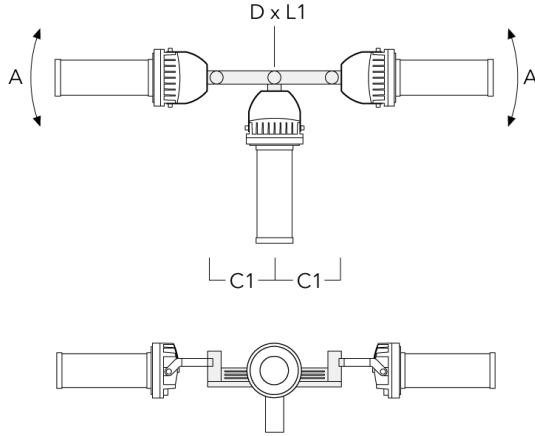

TA3 Mastaufsatztraverse, dreifach (Ø 108 x 200)	147-0098	±90°	650	108 x 200	24.20	108 x 200
---	----------	------	-----	-----------	-------	-----------



## FLC220 LED [GP]

Beschreibung	Artikelnummer	A	C1	D x L1	Gewicht (kg)	D x S
TA4 Mastaufsatztraverse, vierfach (Ø 89 x 200)	147-0099	±90°	650	89 x 200	20.80	89 x 200



TA4 Mastaufsatztraverse, vierfach (Ø 108 x 200)	147-0100	±90°	650	108 x 200	24.20	108 x 200
---	----------	------	-----	-----------	-------	-----------



## Mastschelle TS

## WE-EF Switzerland AG

Himmelrichstrasse 6, 6003 Luzern - Tel: +41 41 210 49 95

info.switzerland@we-ef.com - [https://we-ef.com/ch\\_de](https://we-ef.com/ch_de)

Technische Änderungen und Irrtümer vorbehalten. - Erstellt am 23.10.2024

## FLC220 LED [GP]

Beschreibung	Artikelnummer	D1	Gewicht (kg)	D
TS1-2/M12 Mastschelle, einfach (Ø 102-114)	147-0526	102-114	1.50	102-114

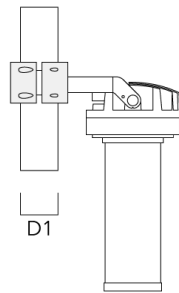
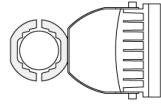

TS1-2/M12 Mastschelle, einfach (Ø 114-133)	147-0544	114-133	1.70	114-133
--	----------	---------	------	---------

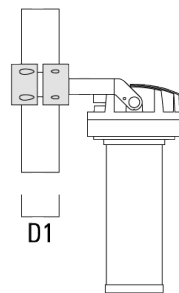
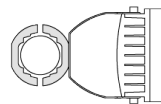



Beschreibung	Artikelnummer	D1	Gewicht (kg)	D
TS2-2/M12 Mastschelle, zweifach (Ø 102-114)	147-0527	102-114	1.50	102-114

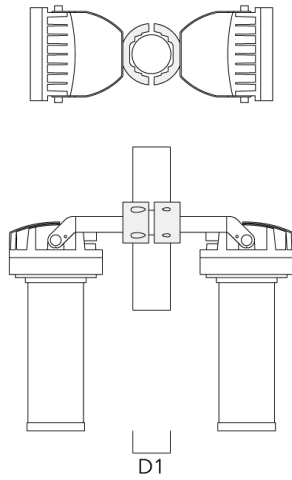

TS2-2/M12 Mastschelle, zweifach (Ø 76-89)	147-0545	76-89	1.40	76-89
---	----------	-------	------	-------

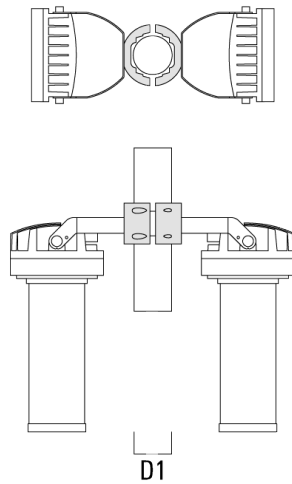

## FLC220 LED [GP]

Beschreibung	Artikelnummer	D1	Gewicht (kg)	D
TS2-2/M12 Mastschelle, zweifach (Ø 114-133)	147-0546	114-133	1.60	114-133

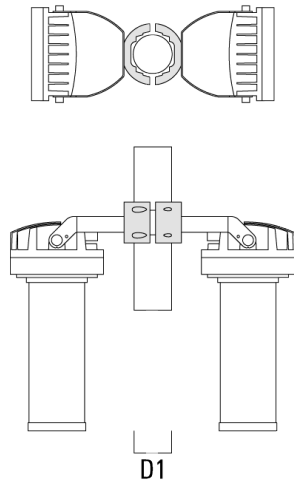

TS1-2/M12 Mastschelle, einfach (Ø 76-89)	147-0543	76-89	1.40	76-89
--	----------	-------	------	-------



## Mastchelle PC

## WE-EF Switzerland AG

Himmelrichstrasse 6, 6003 Luzern - Tel: +41 41 210 49 95

info.switzerland@we-ef.com - [https://we-ef.com/ch\\_de](https://we-ef.com/ch_de)

Technische Änderungen und Irrtümer vorbehalten. - Erstellt am 23.10.2024

## FLC220 LED [GP]

Beschreibung	Artikelnummer	D1	Gewicht (kg)
PC1 76-89/60 Mastschelle, einfach (Ø 76-89)	139-2702	76-89	1.00

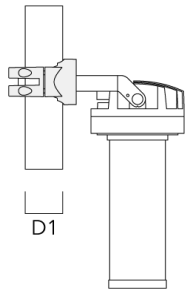

PC2 76-89/60 Mastschelle, zweifach (Ø 76-89)	139-2703	76-89	1.00
--	----------	-------	------

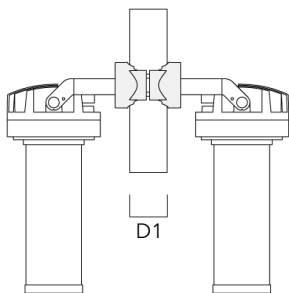
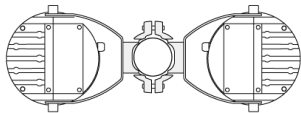

## FLC220 LED [GP]

Beschreibung	Artikelnummer	D1	Gewicht (kg)
PC1 82-109/60 Mastschelle, einfach (Ø 82-109)	139-2704	82-109	1.10

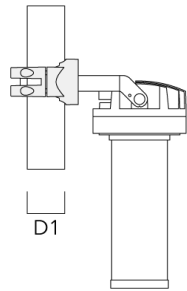
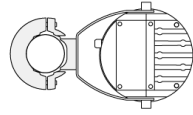

PC2 82-109/60 Mastschelle, zweifach (Ø 82-109)	139-2705	82-109	1.10
---	----------	--------	------



## FLC220 LED [GP]

Beschreibung	Artikelnummer	D1	Gewicht (kg)
PC1 102-114/60 Mastschelle, einfach (Ø 102-114)	139-2706	102-114	1.20

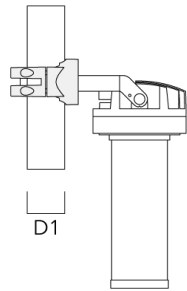
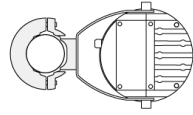

PC2 102-114/60 Mastschelle, zweifach (Ø 102-114)	139-2707	102-114	1.20
---	----------	---------	------



## FLC220 LED [GP]

---

Beschreibung	Artikelnummer	D1	Gewicht (kg)
PC1 114-133/60 Mastschelle, einfach (Ø 144-133)	139-2708	114-133	1.40

---



---

PC2 114-133/60 Mastschelle, zweifach (Ø 114-133)	139-2709	114-133	1.40
---	----------	---------	------

---



**139-2512\_max**

**FLC220 LED [GP]**

**we-ef**

## **Steuerung**

### **R2C Ready to Connect**

Beschreibung	Artikelnummer
R2C Ready to Connect (oben)	430-0019

#### **WE-EF Switzerland AG**

Himmelrichstrasse 6, 6003 Luzern - Tel: +41 41 210 49 95

info.switzerland@we-ef.com - [https://we-ef.com/ch\\_de](https://we-ef.com/ch_de)

Technische Änderungen und Irrtümer vorbehalten. - Erstellt am 23.10.2024

**139-2512\_max**

**FLC220 LED [GP]**

**WE-EF Switzerland AG**

Himmelrichstrasse 6, 6003 Luzern

Tel: +41 41 210 49 95

[info.switzerland@we-ef.com](mailto:info.switzerland@we-ef.com)

[https://we-ef.com/ch\\_de](https://we-ef.com/ch_de)

Technische Änderungen und Irrtümer vorbehalten.

Erstellt am 23.10.2024