



Description

IP66, Class III. IK07. Marine-grade, die-cast aluminium alloy. 5CE superior corrosion protection including PCS hardware. Silicone CCG® Controlled Compression Gasket. Safety glass lens. Electronic control gear in separate gear box (constant current), prewired. Gearbox to be ordered separately. One factory installed flange plug M8 x 1.5. Cable length 3.0 m. CAD-optimised optics for superior illumination and glare control. Factory-installed LED circuit board.



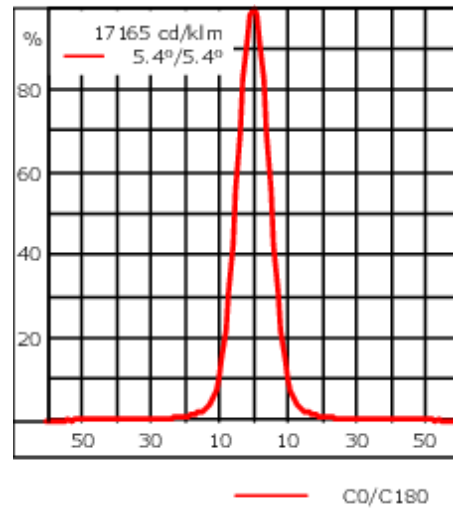

Maximum one internal optical accessory possible. To be specified at time of ordering.

Weight	0.50 kg
Light distribution	symmetric, very narrow beam [EE]
Light source	LED-1/6W / 500 mA - 2700 K
CRI	80
Power supply	EC
LEDs	1
Rated input power	7.5 W
Rated lumens (lm)	
LED Lumen	568.2
Total Lumen	568.2
Ta	25
Nominal Lumen (lm)	
LED Lumen	670
Total Lumen	670
Tc	25



Specifications

Material description

Body	Marine-grade, die-cast aluminium alloy
Lens	Safety glass lens
Colours	 RAL9004 Signal black  RAL9006 White aluminium  RAL9007 Grey aluminium  RAL7016 Anthracite grey  RAL9016 Traffic white
Gasket	Silicone CCG® Controlled Compression Gasket
Fasteners	PCS Polymer Coated Stainless Steel Hardware
Ingress protection	IP66
Impact resistance	IK07
Corrosion resistance	5CE
Windage	0.006 m ²

Electrical description

Power supply	220-240V / 50-60 Hz
Driver / Ballast	Standard, DALI on request
Power factor	> 0.9

139-2444

FLC201 LED

we-ef

Additional information

Lifetime Ta=25° L90B10 > 90000h

Energy efficiency class D-E (Light source)

Fagerhult Lighting Ltd

33-34 Dolben Street, SE1 0UQ London, United Kingdom

<https://we-ef.com/uk>

Subject to technical changes and errors. - Generated on 23/11/2024

139-2444

FLC201 LED

we-ef

Optical Accessories

Linear spread lens

Description	Part ID	C1
IO-180-FLC201-LED	139-2453	41.8



Honeycomb louvre

Description	Part ID	C1
IW-FLC201-LED - [EE][EES]	139-2454	48



Fagerhult Lighting Ltd

33-34 Dolben Street, SE1 0UQ London, United Kingdom

<https://we-ef.com/uk>

Subject to technical changes and errors. - Generated on 23/11/2024

139-2444

FLC201 LED

we-ef

Glare shield

Description	Part ID	A	C1
ES-FLC201-LED	139-2455	59.5	75

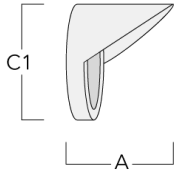

Snoot

Description	Part ID	A	C1
ET-FLC201-LED	139-2456	60	75

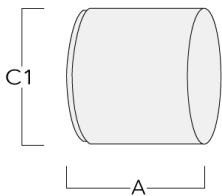

Electrical Accessories

Gear box

Description	Part ID	A	B	C1	C2	Weight (kg)
GB200 R130x80 gear box (small) DALI	139-2555	50	80	159	130	0.30

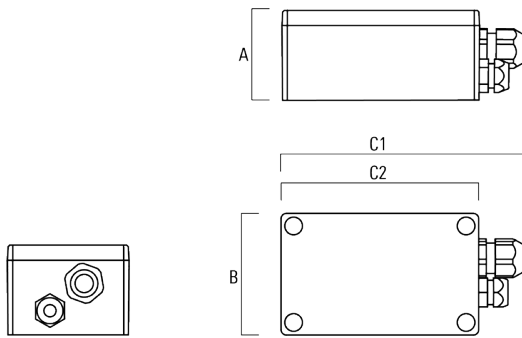

GB200 R200x120 gear box (medium) DALI	139-2622	75	120	229	200	
--	----------	----	-----	-----	-----	--

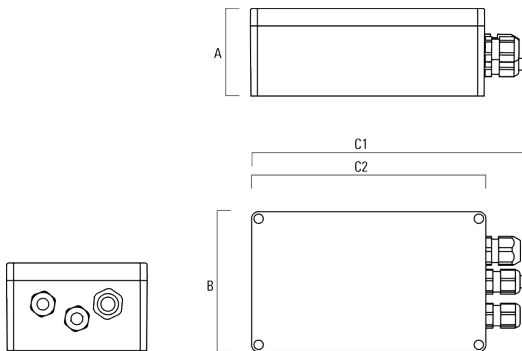

Description	Part ID	A	B	C1	C2	Weight (kg)
GB200 R230x140 gear box (large) SP10 DALI	139-2621	95	140	259	230	

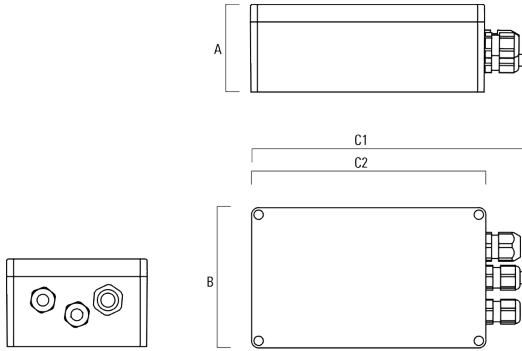

Mounting Accessories

Junction box

Description	Part ID	A	B	C1	C2
JB200 R82 Junction box	139-2590	55	82	140	80

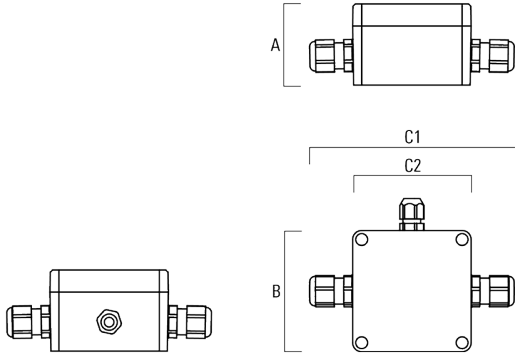

Pole clamp PC

Description	Part ID	D1	Weight (kg)
PC2 114-133/60 Pole clamp, double (Ø 114-133)	139-2709	114-133	1.40

