



### Description

Tunable White. IP66, Class III. IK07. Marine-grade, die-cast aluminium alloy. 5CE superior corrosion protection including PCS hardware. Silicone CCG® Controlled Compression Gasket. Safety glass lens. Electronic control gear in separate gear box (constant current), prewired. Gearbox to be ordered separately. One factory installed flange plug M8 x 1.5. Cable length 10 ft. CAD-optimised optics for superior illumination and glare control. Factory-installed LED circuit board. Tunable White Technology. DALI interface.

Maximum one internal optical accessory possible. To be specified at time of ordering.

Weight	0.50 kg
Light distribution	symmetric, wide beam [B]
Light source	LED-1/4W - 2200-6000 K
CRI	80
Power supply	EC
LEDs	1
Rated input power	5.5 W
<b>Nominal Lumen (lm)</b>	
LED Lumen	420
Total Lumen	420
Tj	85
<b>Rated lumens (lm)</b>	
LED Lumen	317.8
Total Lumen	317.8
Ta	25

139-2450



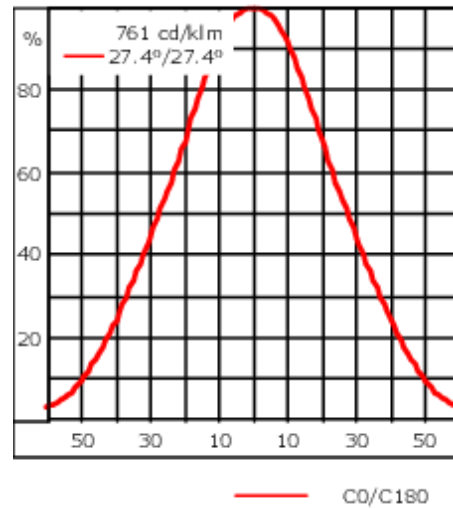
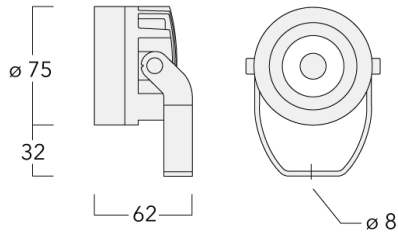

FLC201-TW LED

**we-ef**



## Specifications

### Material description

Body	Marine-grade, die-cast aluminium alloy
Lens	Safety glass lens
Colours	 RAL9004 Signal black  RAL9006 White aluminium  RAL9007 Grey aluminium  RAL7016 Anthracite grey  RAL9016 Traffic white
Gasket	Silicone CCG® Controlled Compression Gasket
Fasteners	PCS Polymer Coated Stainless Steel Hardware
Ingress protection	IP66
Impact resistance	IK07
Corrosion resistance	5CE
Windage	0.065 ft <sup>2</sup>

### Electrical description

Power supply	220-240V / 50-60 Hz
Driver / Ballast	DALI
Power factor	> 0.9

#### WE-EF LEUCHTEN GmbH

Töpinger Straße 16, 29646 Bispingen, Germany - Phone: +49 5194 909-0

info@we-ef.com - <https://we-ef.com>

Subject to technical changes and errors. - Generated on 23/10/2024

**139-2450**

**FLC201-TW LED**

**we-ef**

**Additional information**

---

Lifetime Ta=25° L90B10 > 90000h

Energy efficiency class D (Light source)

---

**WE-EF LEUCHTEN GmbH**

Töpinger Straße 16, 29646 Bispingen, Germany - Phone: +49 5194 909-0

info@we-ef.com - <https://we-ef.com>

Subject to technical changes and errors. - Generated on 23/10/2024

139-2450

FLC201-TW LED

**we-ef**

## Optical Accessories

### Linear spread lens

Description	Part ID	C1
IO-180-FLC201-LED	139-2453	41.8



### Honeycomb louvre

Description	Part ID	C1
IW-FLC201-LED - [EE][EES]	139-2454	48



### Glare shield

#### WE-EF LEUCHTEN GmbH

Töpinger Straße 16, 29646 Bispingen, Germany - Phone: +49 5194 909-0

info@we-ef.com - <https://we-ef.com>

Subject to technical changes and errors. - Generated on 23/10/2024

139-2450

**FLC201-TW LED**

---

Description	Part ID	A	C1
ES-FLC201-LED	139-2455	59.5	75

---

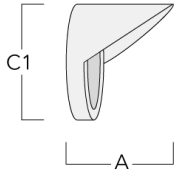

---

**Snoot**

---

Description	Part ID	A	C1
ET-FLC201-LED	139-2456	60	75

---

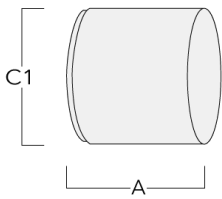

139-2450

FLC201-TW LED

## Mounting Accessories

### Junction box

Description	Part ID	A	B	C1	C2
JB200 R82 Junction box	139-2590	55	82	140	80

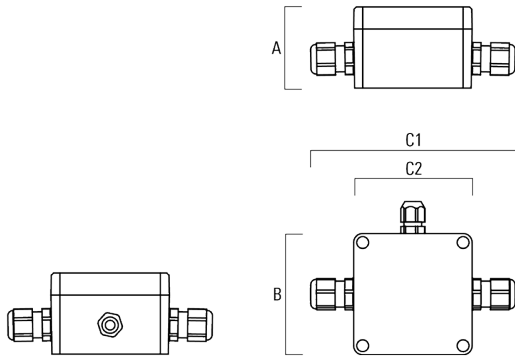

**Electrical Accessories**

**Gear box**

Description	Part ID	A	B	C1	C2
GB200 R200x120 gear box (medium) TW	139-2632	75	120	229	200

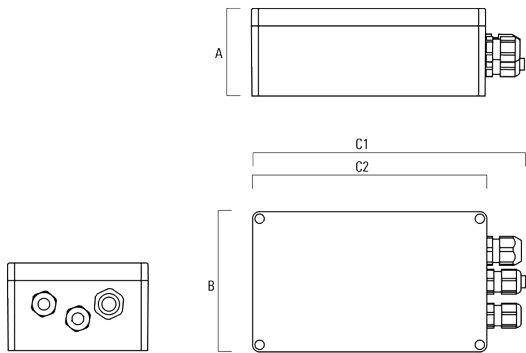

GB200 R230x140 gear box (large) SP10 TW	139-2633	95	140	255	230
---	----------	----	-----	-----	-----

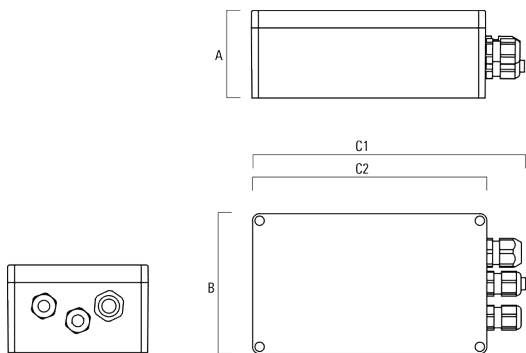

**139-2450**

**FLC201-TW LED**

**WE-EF LEUCHTEN GmbH**

Töpinger Straße 16, 29646 Bispingen, Germany

Phone: +49 5194 909-0

[info@we-ef.com](mailto:info@we-ef.com)

<https://we-ef.com>

Subject to technical changes and errors.

Generated on 23/10/2024