



Description

IP66, Class III. IK07. Marine-grade, die-cast aluminium alloy. 5CE superior corrosion protection including PCS hardware. Silicone CCG® Controlled Compression Gasket. Safety glass lens.

Electronic control gear in separate gear box (constant current), prewired. Gearbox to be ordered separately. One factory installed flange plug M8 x 1.5. Cable length 3.0 m. CAD-optimised optics for superior illumination and glare control. Factory-installed LED circuit board. Tunable White Technology. DALI interface.

Maximum one internal optical accessory possible. To be specified at time of ordering.

Weight	0.50 kg
Light distribution	symmetric, wide beam [B]
Light source	LED-1/4W - 2200-6000 K
CRI	80
Power supply	EC
LEDs	1
Rated input power	5.5 W
Nominal Lumen (lm)	
LED Lumen	420
Total Lumen	420
Tj	85
Rated lumens (lm)	
LED Lumen	317.8
Total Lumen	317.8
Ta	25

139-2450



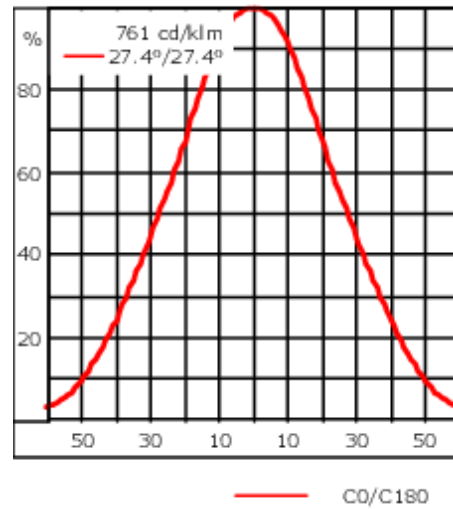

FLC201-TW LED

we-ef



Specifications

Material description

Body	Marine-grade, die-cast aluminium alloy
Lens	Safety glass lens
Colours	 RAL9004 Signal black  RAL9007 Grey aluminium  RAL7016 Anthracite grey  RAL9016 Traffic white
Gasket	Silicone CCG® Controlled Compression Gasket
Fasteners	PCS Polymer Coated Stainless Steel Hardware
Ingress protection	IP66
Impact resistance	IK07
Corrosion resistance	5CE
Windage	0.065 ft ²

Electrical description

Driver / Ballast	DALI
Power factor	> 0.9

Additional information

Lifetime	Ta=25° L90B10 > 90000h
----------	------------------------

WE-EF LIGHTING (Thailand) Co., Ltd.

57 Moo 5, Kingkaew Rd., Bangplee, 10540 Samutprakarn - Phone: +66 2 738 96 20 - Fax: +66 2 738 96 29

<https://we-ef.com/asia>

Subject to technical changes and errors. - Generated on 23/10/2024

139-2450

FLC201-TW LED

we-ef

Optical Accessories

Linear spread lens

Description	Part ID	C1
Linear spread lens IO-180	139-2453	41.8



Honeycomb louvre

Description	Part ID	C1
Honeycomb louvre IW	139-2454	48



Glare shield

WE-EF LIGHTING (Thailand) Co., Ltd.

57 Moo 5, Kingkaew Rd., Bangplee, 10540 Samutprakarn - Phone: +66 2 738 96 20 - Fax: +66 2 738 96 29

<https://we-ef.com/asia>

Subject to technical changes and errors. - Generated on 23/10/2024

139-2450

we-ef

FLC201-TW LED

Description	Part ID	A	C1
Glare shield ES	139-2455	59.5	75

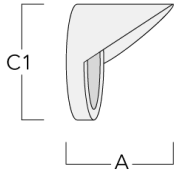

Snoot

Description	Part ID	A	C1
Snoot ET	139-2456	60	75

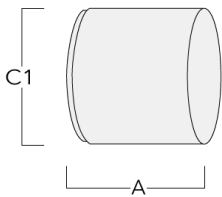

WE-EF LIGHTING (Thailand) Co., Ltd.

57 Moo 5, Kingkaew Rd., Bangplee, 10540 Samutprakarn - Phone: +66 2 738 96 20 - Fax: +66 2 738 96 29

<https://we-ef.com/asia>

Subject to technical changes and errors. - Generated on 23/10/2024

Mounting Accessories

Junction box

Description	Part ID	A	B	C1	C2
Junction box JB200 R82	139-2590	55	82	140	80



Electrical Accessories

Gear box

Description	Part ID	A	B	C1	C2
GB200 R200x120 gear box (medium) TW	139-2632	75	120	229	200

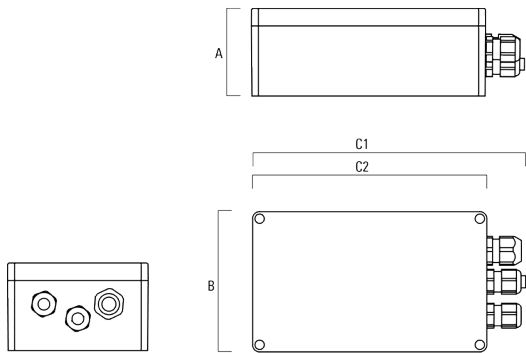

GB200 R230x140 gear box (large) SP10 TW	139-2633	95	140	255	230
---	----------	----	-----	-----	-----

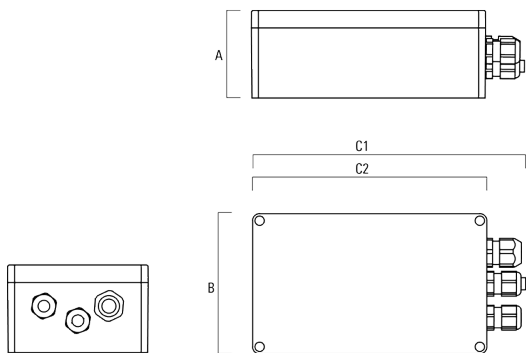

139-2450

FLC201-TW LED

WE-EF LIGHTING (Thailand) Co., Ltd.

57 Moo 5, Kingkaew Rd., Bangplee, 10540 Samutprakarn

Phone: +66 2 738 96 20

Fax: +66 2 738 96 29

<https://we-ef.com/asia>

Subject to technical changes and errors.

Generated on 23/10/2024