

139-2411

FLC210-CC LED

**we-ef**



### Description

Changement de couleur. IP66, SKIII. IK07. Corps en fonte d'aluminium. Visserie inox avec traitement PCS. Protection contre la corrosion 5CE. Joint silicone. Verre de sécurité. Un presse-étoupe en standard, deux en variante. Driver séparé. Optique optimisé et développé par CAO pour gestion de l'efficacité et de l'éblouissement, OLC® One LED Concept. Technologie Colour Boost, Interface DMX.

Poids	4.00 kg
Distribution de la lumière	faisceau symétrique, médium [M]
Source lumineuse	LED-3/12W - RGBW/4K
IRC	20/80
Alimentation électrique	ballast électronique
LEDs	3
Rated input power	15 W
<b>Flux lumineux nominal (lm)</b>	
LED Lumen	340
Total Lumen	1020
Tj	85
<b>Rated lumens (lm)</b>	
LED Lumen	260
Total Lumen	779.9
Ta	25

### WE-EF Switzerland AG

Himmelrichstrasse 6, 6003 Luzern - Téléphone: +41 22 752 49 94

info.switzerland@we-ef.com - [https://we-ef.com/ch\\_fr](https://we-ef.com/ch_fr)

Sous réserve de modifications techniques et d'erreurs. - Généré le 10/03/2025

139-2411



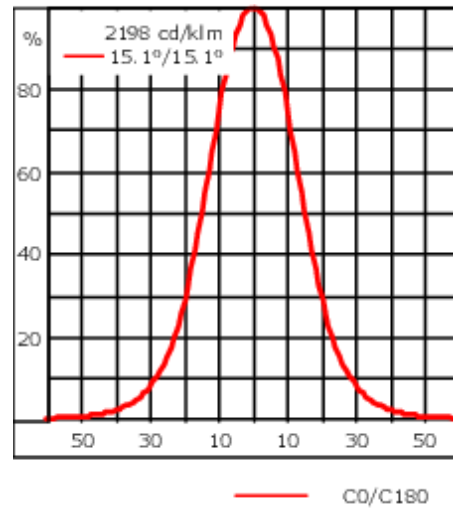

FLC210-CC LED

**we-ef**



## Spécifications

### Description du matériel

Corps	Corps en fonte d'aluminium
Lentille	Verre de sécurité
Couleurs	 RAL9004 Noir de sécurité  RAL9007 Aluminium gris  RAL7016 Gris anthracite  RAL9016 Blanc signalisation
Joint	CCG® Joint silicone
Visserie	Visserie inox avec traitement PCS
IP	IP66
IK	IK07
Protection contre la corrosion	5CE
Surface exposée au vent	0.018 m <sup>2</sup>

### Description électrique

Driver	DMX
Power factor	> 0.9

#### WE-EF Switzerland AG

Himmelrichstrasse 6, 6003 Luzern - Téléphone: +41 22 752 49 94

info.switzerland@we-ef.com - [https://we-ef.com/ch\\_fr](https://we-ef.com/ch_fr)

Sous réserve de modifications techniques et d'erreurs. - Généré le 10/03/2025

**139-2411**

**FLC210-CC LED**

**we-ef**

**Informations complémentaires**

---

Durée de vie Ta=25° L90B10 > 90000h

Classe d'efficacité  
énergétique G

---

**WE-EF Switzerland AG**

Himmelrichstrasse 6, 6003 Luzern - Téléphone: +41 22 752 49 94

info.switzerland@we-ef.com - [https://we-ef.com/ch\\_fr](https://we-ef.com/ch_fr)

Sous réserve de modifications techniques et d'erreurs. - Généré le 10/03/2025

## Accessoires Optiques

### Visière

Description	Référence	A	C1
ES-FLC210-LED	139-2406	86	149

### Canon anti-éblouissement

Description	Référence	A	C1
ET-FLC210-LED	139-2407	86	149

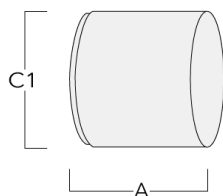

**Accessoires Électriques**

**Gear box**

Description	Référence	A	B	C1	C2	Poids (kg)
GB200 R200x120 gear box (medium)	139-2526	75	120	229	200	1.05

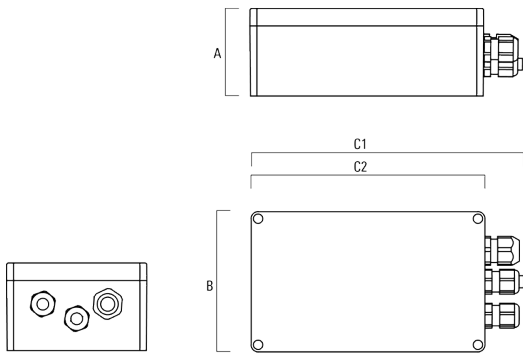

GB200 R230x140 gear box (large)	139-2527	95	140	259	230	1.20
---------------------------------	----------	----	-----	-----	-----	------

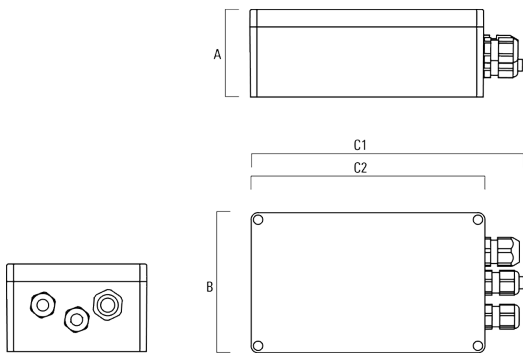

## Accessoires d'installation

## Collier pour mâts PC

Description	Référence	D1	Poids (kg)
PC2 76-89/60 collier double pour tube (Ø 76-89)	139-2703	76-89	1.00

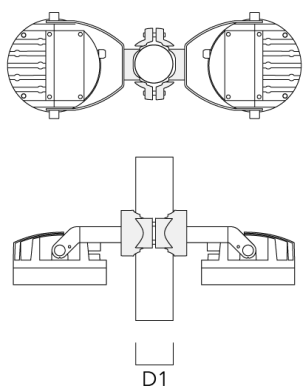

PC1 76-89/60 collier simple (Ø 76-89)	139-2702	76-89	1.00
---------------------------------------	----------	-------	------

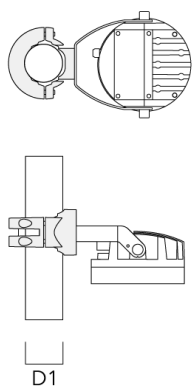

Description	Référence	D1	Poids (kg)
PC2 102-114/60 collier double pour tube (Ø 102-114)	139-2707	102-114	1.20



PC1 102-114/60 collier simple (Ø 102-114)	139-2706	102-114	1.20
---	----------	---------	------

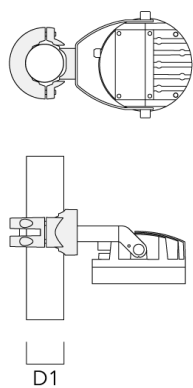

---

Description	Référence	D1	Poids (kg)
PC2 114-133/60 collier double pour tube (Ø 114-133)	139-2709	114-133	1.40

---

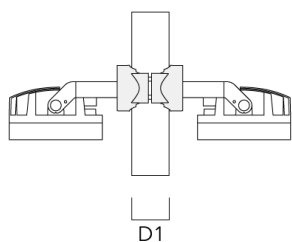
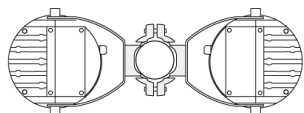

---

PC1 114-133/60 collier simple (Ø 114-133)	139-2708	114-133	1.40
---	----------	---------	------

---

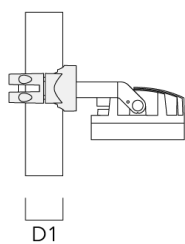
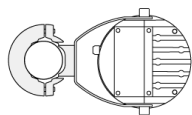



## FLC210-CC LED

Description	Référence	D1	Poids (kg)
PC2 82-109/60 collier double pour tube (Ø 82-109)	139-2705	82-109	1.10

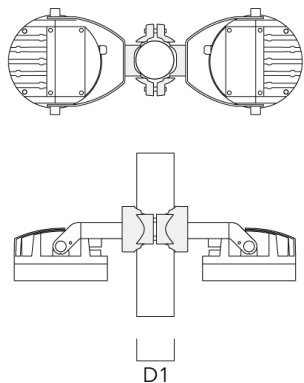

PC1 82-109/60 collier simple (Ø 82-109)	139-2704	82-109	1.10
---	----------	--------	------

