

**FLC210 LED COLOR CHANGER**



**Description**

RGBW/RGBA Color Changer.

IP66, Class III. IK07. Marine-grade, die-cast aluminum alloy. 5CE superior corrosion protection including PCS hardware. Silicone CCG® Controlled Compression Gasket. Safety glass lens. One cable gland. Second gland for through-wiring on request. Integral driver in separate driver box (constant current), prewired; to be ordered separately. CAD-optimized optics for superior illumination and glare control. OLC® One LED Concept. Factory-installed LED circuit board. Color Changer technology. DMX interface.

Specify product with 7 Digit product code - Finish Color. Accessories, such as mounting, optical, and electrical, must be specified separately.

Example: XXX-XXXX - 9004 (Black)  
+ XXX-XXXX (Accessory 1)

Weight	8.80 lb
Light distribution	symmetric, medium beam [M]
Light source	LED-3/12W - RGBA
CRI	20
Power supply	electronic gear
LEDs	3
Rated input power	15 W
<b>Nominal Lumen (lm)</b>	
LED Lumen	275
Total Lumen	825
Tj	85
<b>Delivered lumens (lm)</b>	
LED Lumen	210.3
Total Lumen	630.8
Ta	25

**WE-EF LIGHTING USA, LLC**

410-D Keystone Drive, 15086 Warrendale, PA 15086 - Phone: +1 724 742 0030  
customersupport.usa@we-ef.com - <https://we-ef.com/us>  
Subject to technical changes and errors. - Generated on 03/10/2025

**FLC210 LED COLOR CHANGER**

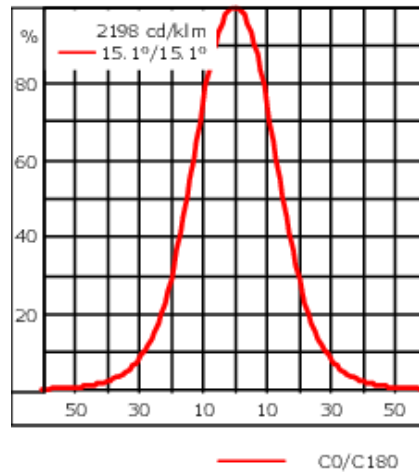
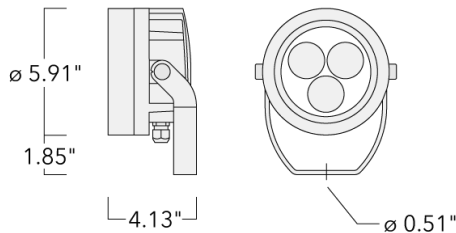

**Specifications**

**Material description**

Body	Marine-grade, die-cast aluminium alloy
Lens	Safety glass lens
Colors	<div style="display: flex; flex-direction: column; gap: 5px;"> <div><span style="display: inline-block; width: 15px; height: 15px; background-color: black; margin-right: 5px;"></span> RAL9004 Black</div> <div><span style="display: inline-block; width: 15px; height: 15px; background-color: grey; margin-right: 5px;"></span> RAL9007 Grey Metallic</div> <div><span style="display: inline-block; width: 15px; height: 15px; background-color: white; margin-right: 5px;"></span> RAL9016 White</div> <div><span style="display: inline-block; width: 15px; height: 15px; background-color: darkgrey; margin-right: 5px;"></span> RAL8019 Dark Bronze</div> </div>
Gasket	CCG® Silicone rubber gasket
Fasteners	PCS Polymer Coated Stainless Steel Hardware
Ingress protection	IP66
Impact resistance	IK07
Corrosion resistance	5CE
Windage	0.018 m <sup>2</sup>

**Electrical description**

Driver / Ballast	DMX
Power factor	> 0.9

**WE-EF LIGHTING USA, LLC**

410-D Keystone Drive, 15086 Warrendale, PA 15086 - Phone: +1 724 742 0030  
 customersupport.usa@we-ef.com - <https://we-ef.com/us>  
 Subject to technical changes and errors. - Generated on 03/10/2025

**139-2413**

**we-ef**

**FLC210 LED COLOR CHANGER**

**Additional information**

---

Lifetime Ta=25° L90B10 > 90000h

Listings ETL, UL-1598, CSA-C22.2#250.0. Suitable for Wet Locations.

---

**WE-EF LIGHTING USA, LLC**

410-D Keystone Drive, 15086 Warrendale, PA 15086 - Phone: +1 724 742 0030  
customersupport.usa@we-ef.com - <https://we-ef.com/us>

Subject to technical changes and errors. - Generated on 03/10/2025

**Optical Accessories**

**Glare shield**

---

Description	Part ID	A	C1
ES-FLC210-LED	139-2406	3.39	5.87
ES-FLC210-CC-LED	139-6981	3.39	5.87

---

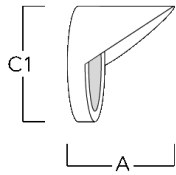

**FLC210 LED COLOR CHANGER**

**Snoot**

---

Description	Part ID	A	C1
ET-FLC210-LED	139-2407	3.39	5.87

---

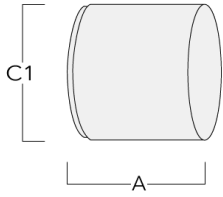

---

ET-FLC210-CC-LED	139-6982	3.39	5.87
------------------	----------	------	------

---

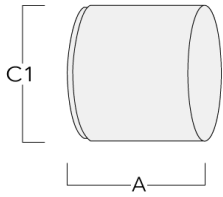

**FLC210 LED COLOR CHANGER**

**Electrical Accessories**

**Gear box**

Description	Part ID	A	B	C1	C2	Weight (lb)
GB200 R200x120 gear box (medium) 120-277V, 0-10V	139-2526	2.95	4.72	9.02	7.87	1.05

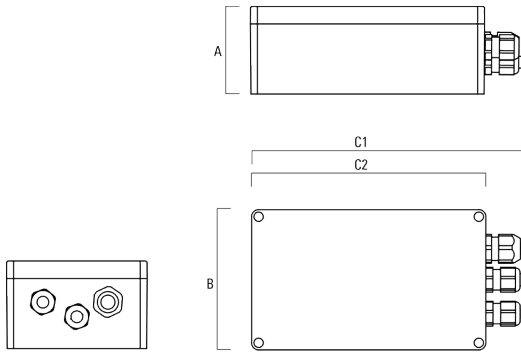

GB200 R230x140 gear box (large)	139-2527	95	140	259	230	1.20
---------------------------------	----------	----	-----	-----	-----	------

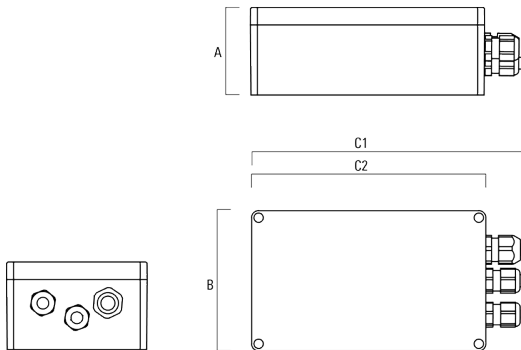

139-2413

**we-ef**

**FLC210 LED COLOR CHANGER**

Description	Part ID	A	B	C1	C2	Weight (lb)
FLC210 RGBW Gear Box	139-6979	3	4.7	9	7.9	

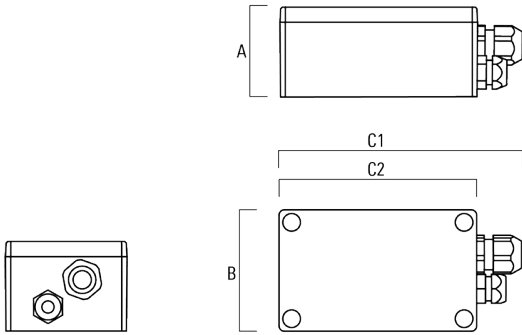

**WE-EF LIGHTING USA, LLC**

410-D Keystone Drive, 15086 Warrendale, PA 15086 - Phone: +1 724 742 0030  
customersupport.usa@we-ef.com - <https://we-ef.com/us>  
Subject to technical changes and errors. - Generated on 03/10/2025

**FLC210 LED COLOR CHANGER**

**Mounting Accessories**

**Pole clamp PC**

---

Description	Part ID	D1	Weight (lb)
PC2 76-89/60 Pole clamp, double (Ø 3"-3.5")	139-2703	3.0-3.50	2.20

---

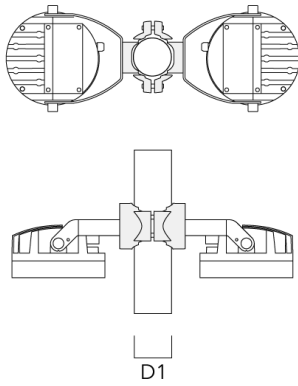

---

PC1 76-89/60 Pole clamp, single (Ø 3"-3.5")	139-2702	3.0-3.50	2.20
---	----------	----------	------

---

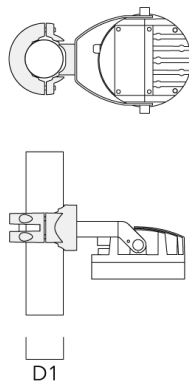



**FLC210 LED COLOR CHANGER**

---

Description	Part ID	D1	Weight (lb)
PC2 102-114/60 Pole clamp, double (Ø 4"-4.5")	139-2707	4.0-4.50	2.65

---



---

PC1 102-114/60 Pole clamp, single (Ø 4"-4,5")	139-2706	4.0-4.50	2.65
--	----------	----------	------

---



**WE-EF LIGHTING USA, LLC**

410-D Keystone Drive, 15086 Warrendale, PA 15086 - Phone: +1 724 742 0030  
customersupport.usa@we-ef.com - <https://we-ef.com/us>  
Subject to technical changes and errors. - Generated on 03/10/2025

**FLC210 LED COLOR CHANGER**

---

Description	Part ID	D1	Weight (lb)
PC2 114-133/60 Pole clamp, double (Ø 4.5"-5.25")	139-2709	4.5-5.25	3.10

---



---

PC1 114-133/60 Pole clamp, single (Ø 4.5"-5.25")	139-2708	4.5-5.25	3.10
---	----------	----------	------

---



**WE-EF LIGHTING USA, LLC**

410-D Keystone Drive, 15086 Warrendale, PA 15086 - Phone: +1 724 742 0030  
customersupport.usa@we-ef.com - <https://we-ef.com/us>  
Subject to technical changes and errors. - Generated on 03/10/2025

139-2413

**we-ef**

**FLC210 LED COLOR CHANGER**

---

Description	Part ID	D1	Weight (lb)
PC2 82-109/60 Pole clamp, double (Ø 3.25"-4.25")	139-2705	3.20-4.30	2.40

---



---

PC1 82-109/60 Pole camp, single (Ø 3.25"-4.3")	139-2704	3.20-4.30	2.40
--	----------	-----------	------

---



**WE-EF LIGHTING USA, LLC**

410-D Keystone Drive, 15086 Warrendale, PA 15086 - Phone: +1 724 742 0030  
customersupport.usa@we-ef.com - <https://we-ef.com/us>  
Subject to technical changes and errors. - Generated on 03/10/2025