



### Description

Tunable white projector. IP66, Class I. IK07. Marine-grade, die-cast aluminium alloy. 5CE superior corrosion protection including PCS hardware. Silicone CCG® Controlled Compression Gasket. Safety glass lens. One cable gland. Second gland for through-wiring on request.

Integral EC electronic converter in thermally-separated compartment. CAD-optimised optics for superior illumination and glare control. OLC® One LED Concept. Factory-installed LED circuit board with Tunable White Technology.

DALI interface. For other control interface options to suit specific project requirements, contact WE-EF.

Weight	4.00 kg
Light distribution	symmetric, wide beam [B]
Light source	LED-3/11W - 2200-6000 K
CRI	80
Power supply	EC
LEDs	3
Rated input power	13 W
<b>Nominal Lumen (lm)</b>	
LED Lumen	420
Total Lumen	1260
Tj	85
<b>Rated lumens (lm)</b>	
LED Lumen	317.8
Total Lumen	953.5
Ta	25

139-2417



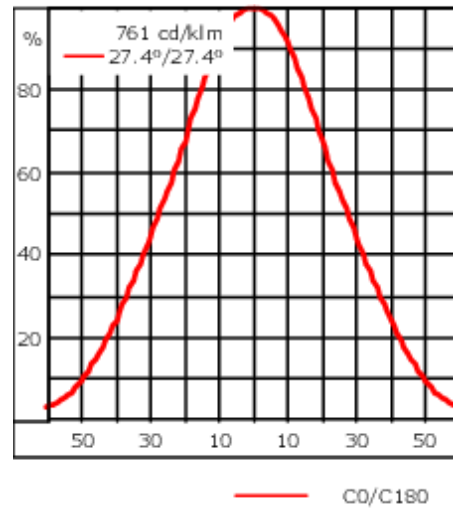
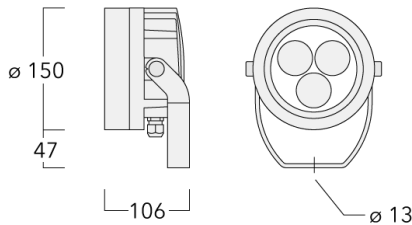

FLC210-TW LED

we-ef



## Specifications

### Material description

Body	Marine-grade, die-cast aluminium alloy
Lens	Safety glass lens
Colours	 RAL9004 Signal black  RAL9007 Grey aluminium  RAL7016 Anthracite grey  RAL9016 Traffic white
Gasket	Silicone CCG® Controlled Compression Gasket
Fasteners	PCS Polymer Coated Stainless Steel Hardware
Ingress protection	IP66
Impact resistance	IK07
Corrosion resistance	5CE
Windage	0.018 m <sup>2</sup>

### Electrical description

Power supply	220-240V / 50-60 Hz
Driver / Ballast	DALI
Power factor	> 0.9

### Additional information

#### WE-EF LIGHTING (Thailand) Co., Ltd.

57 Moo 5, Kingkaew Rd., Bangplee, 10540 Samutprakarn - Phone: +66 2 738 96 20 - Fax: +66 2 738 96 29

<https://we-ef.com/asia>

Subject to technical changes and errors. - Generated on 23/11/2024

139-2417

FLC210-TW LED

**we-ef**

## Optical Accessories

### Glare shield

Description	Part ID	A	C1
Glare shield ES	139-2406	86	149

### Snoot

Description	Part ID	A	C1
Snoot ET	139-2407	86	149

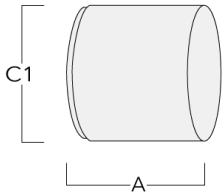

139-2417

FLC210-TW LED

**we-ef**

**Honeycomb louvre**

---

Description	Part ID	C1
Honeycomb louvre IW for [B]	139-9414	100

---

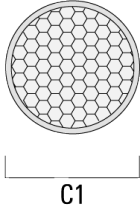

---

Honeycomb louvre IW for [E]	139-9415	100
-----------------------------	----------	-----

---

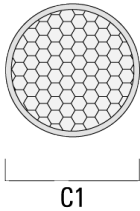

**WE-EF LIGHTING (Thailand) Co., Ltd.**

57 Moo 5, Kingkaew Rd., Bangplee, 10540 Samutprakarn - Phone: +66 2 738 96 20 - Fax: +66 2 738 96 29

<https://we-ef.com/asia>

Subject to technical changes and errors. - Generated on 23/11/2024

139-2417

**we-ef**

**FLC210-TW LED**

---

Description	Part ID	C1
Honeycomb louvre IW for [M]	139-9413	100

---

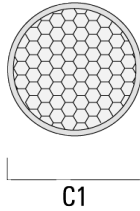

---

**Linear spread lens**

---

Description	Part ID	C1
Linear spread lens IO-180 for [B]	139-9411	100

---

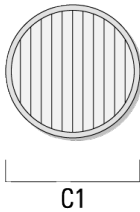

---

**WE-EF LIGHTING (Thailand) Co., Ltd.**

57 Moo 5, Kingkaew Rd., Bangplee, 10540 Samutprakarn - Phone: +66 2 738 96 20 - Fax: +66 2 738 96 29

<https://we-ef.com/asia>

Subject to technical changes and errors. - Generated on 23/11/2024

**FLC210-TW LED**

---

Description	Part ID	C1
Linear spread lens IO-180 for [E]	139-9412	100

---

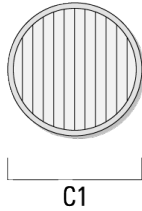

---

Linear spread lens IO-180 for [M]	139-9410	100
-----------------------------------	----------	-----

---

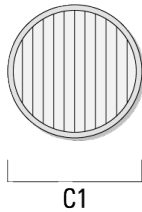

## Mounting Accessories

### Junction box

Description	Part ID	Additional information	A	B	C1	Weight (kg)
Junction box JB20 - Cable side entries	310-9013	Junction boxes are made from marine-grade, die-cast aluminium alloy. IK10. IP66. For side entries and suitable to be used with cable glands.	180	143	51	1.02

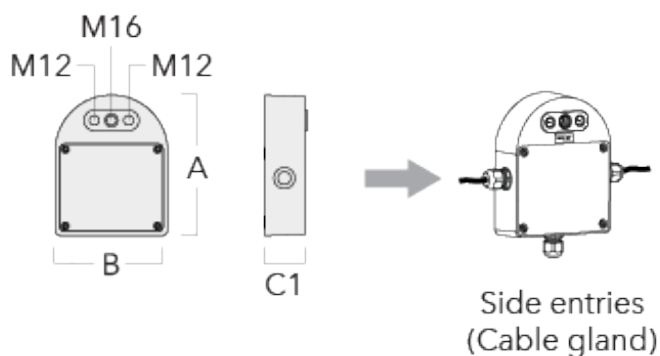

Junction box JB20 - Conduit side entries	310-9014	Junction boxes are made from marine-grade, die-cast aluminium alloy. IK10. IP66. For side entries and suitable to be used with conduits.	180	143	51	1.02
--	----------	--	-----	-----	----	------

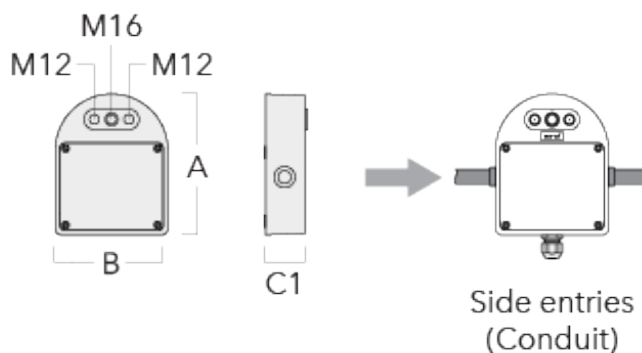

**FLC210-TW LED**

Description	Part ID	Additional information	A	B	C1	Weight (kg)
Junction box JB20 - Wall entries	310-9018	Junction boxes are made from marine-grade, die-cast aluminium alloy. IK10. IP66. For wall entries.	180	143	51	1.02

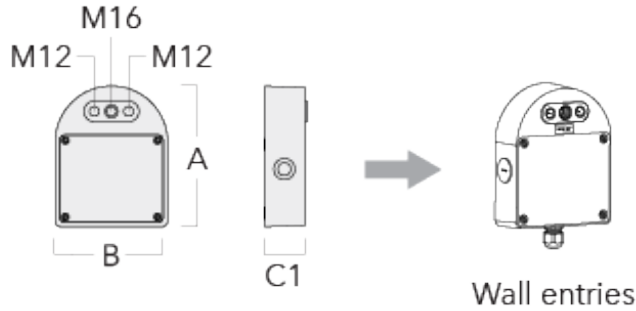

**Pole clamp PC - Rotatable**

Description	Part ID	D1	Weight (kg)
PC2 76-89/60 Pole clamp, double (Ø 76-89)	139-2703	76-89	1.00

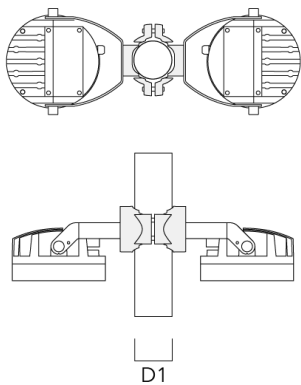



139-2417

**we-ef**

**FLC210-TW LED**

---

Description	Part ID	D1	Weight (kg)
PC1 76-89/60 Pole clamp, single (Ø 76-89)	139-2702	76-89	1.00

---

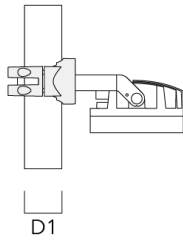
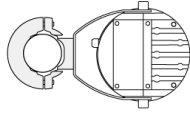

---

PC2 102-114/60 Pole clamp, double (Ø 102-114)	139-2707	102-114	1.20
---	----------	---------	------

---

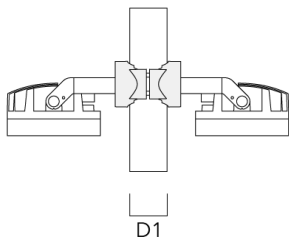
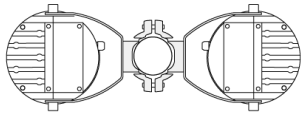

**WE-EF LIGHTING (Thailand) Co., Ltd.**

57 Moo 5, Kingkaew Rd., Bangplee, 10540 Samutprakarn - Phone: +66 2 738 96 20 - Fax: +66 2 738 96 29

<https://we-ef.com/asia>

Subject to technical changes and errors. - Generated on 23/11/2024

139-2417

**we-ef**

**FLC210-TW LED**

---

Description	Part ID	D1	Weight (kg)
PC1 102-114/60 Pole clamp, single (Ø 102-114)	139-2706	102-114	1.20

---

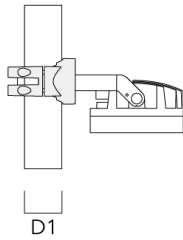
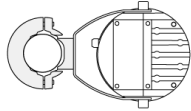

---

PC1 114-133/60 Pole clamp, single (Ø 114-133)	139-2708	114-133	1.40
--	----------	---------	------

---

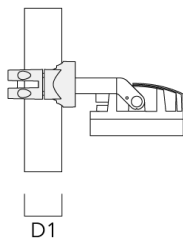
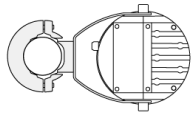

139-2417

**we-ef**

**FLC210-TW LED**

---

Description	Part ID	D1	Weight (kg)
PC2 82-109/60 Pole camp, double (Ø 82-109)	139-2705	82-109	1.10

---



---

PC1 82-109/60 Pole camp, single (Ø 82-109)	139-2704	82-109	1.10
--	----------	--------	------

---

