



Description

Tunable White. IP66, Class I. Class II on request. IK07. Marine-grade, die-cast aluminium alloy. 5CE superior corrosion protection including PCS hardware. Silicone CCG® Controlled Compression Gasket. Safety glass lens. One cable gland. Second gland for through-wiring on request. Integral EC electronic converter in thermally-separated compartment. CAD-optimised optics for superior illumination and glare control. OLC® One LED Concept. Factory-installed LED circuit board, Tunable White Technology. DALI interface.

Weight	4.00 kg
Light distribution	symmetric, medium beam [M]
Light source	LED-3/11W - 2200-6000 K
CRI	80
Power supply	EC
LEDs	3
Rated input power	13 W
Nominal Lumen (lm)	
LED Lumen	420
Total Lumen	1260
Tj	85
Rated lumens (lm)	
LED Lumen	321.1
Total Lumen	963.4
Ta	25

139-2418



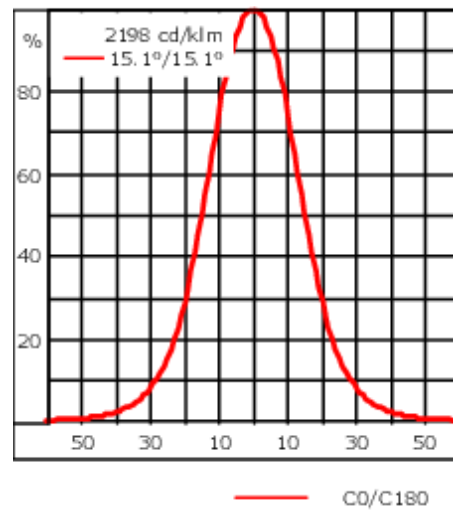

FLC210-TW LED

we-ef



Specifications

Material description

Body	Marine-grade, die-cast aluminium alloy
Lens	Safety glass lens
Colours	 RAL9004 Signal black  RAL9006 White aluminium  RAL9007 Grey aluminium  RAL7016 Anthracite grey  RAL9016 Traffic white
Gasket	Silicone CCG® Controlled Compression Gasket
Fasteners	PCS Polymer Coated Stainless Steel Hardware
Ingress protection	IP66
Impact resistance	IK07
Corrosion resistance	5CE
Windage	0.018 m ²

Electrical description

Power supply	220-240V / 50-60 Hz
Driver / Ballast	DALI
Power factor	> 0.9
Surge protection	6/6 kV (optional SP10)

Fagerhult Lighting Ltd

33-34 Dolben Street, SE1 0UQ London, United Kingdom

<https://we-ef.com/uk>

Subject to technical changes and errors. - Generated on 23/11/2024

139-2418

FLC210-TW LED

we-ef

Additional information

Lifetime Ta=25° L90B10 > 90000h

Energy efficiency class E (Light source)

Optical Accessories

Glare shield

Description	Part ID	A	C1
ES-FLC210-LED	139-2406	86	149

Snoot

Description	Part ID	A	C1
ET-FLC210-LED	139-2407	86	149

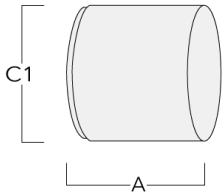

Electrical Accessories

Gear box

Description	Part ID	A	B	C1	C2	Weight (kg)
GB200 R200x120 gear box (medium)	139-2526	75	120	229	200	1.05

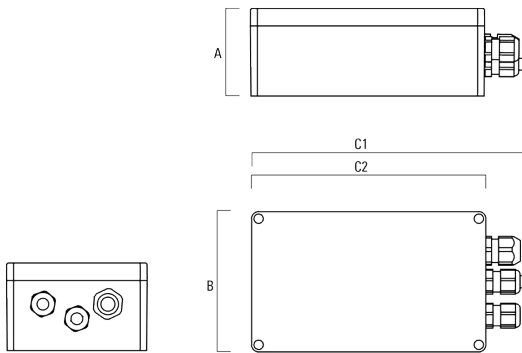

GB200 R230x140 gear box (large)	139-2527	95	140	259	230	1.20
---------------------------------	----------	----	-----	-----	-----	------

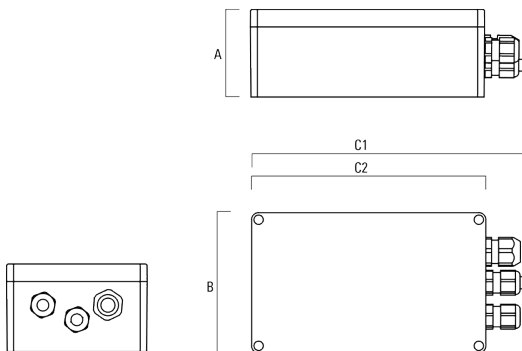

Mounting Accessories

Pole clamp PC

Description	Part ID	D1	Weight (kg)
PC2 76-89/60 Pole clamp, double (Ø 76-89)	139-2703	76-89	1.00



PC1 76-89/60 Pole clamp, single (Ø 76-89)	139-2702	76-89	1.00
---	----------	-------	------



FLC210-TW LED

Description	Part ID	D1	Weight (kg)
PC2 102-114/60 Pole clamp, double (Ø 102-114)	139-2707	102-114	1.20



PC1 102-114/60 Pole clamp, single (Ø 102-114)	139-2706	102-114	1.20
--	----------	---------	------



FLC210-TW LED

Description	Part ID	D1	Weight (kg)
PC1 114-133/60 Pole clamp, single (Ø 114-133)	139-2708	114-133	1.40



PC2 82-109/60 Pole camp, double (Ø 82-109)	139-2705	82-109	1.10
--	----------	--------	------

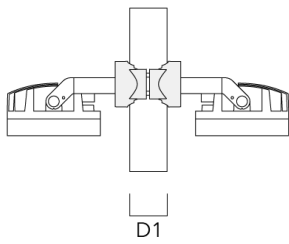

139-2418

FLC210-TW LED

we-ef

Description	Part ID	D1	Weight (kg)
PC1 82-109/60 Pole camp, single (Ø 82-109)	139-2704	82-109	1.10

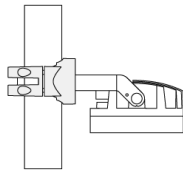

D1

Fagerhult Lighting Ltd

33-34 Dolben Street, SE1 0UQ London, United Kingdom

<https://we-ef.com/uk>

Subject to technical changes and errors. - Generated on 23/11/2024