



Beschreibung

Projektor [ZP] zur Erzeugung von scharf abgegrenzten Lichtkreisen. Sphärisches und asphärisches, zweifaches Plankonvexlinsensystem aus Glas zur Erzeugung eines parallelen Lichtbündels.

IP66, SKI. IK07. Korrosionsbeständiger Aluminiumguss. PCS beschichtete Edelstahlschrauben. 5CE Korrosionsschutz. CCG® Silikondichtung. Sicherheitsglas. Eine Kabelverschraubung, eine zweite Kabelverschraubung zur Durchverdrahtung auf Anfrage. PMMA LED Linse. Eingebaute LED Platine, austauschbar. Eingebaute elektronische Betriebsgeräte, thermisch getrennt.

Gewicht	8.20 kg
Lichtverteilung	symmetrisch Zoom-Projector [ZP] - max Öffnungswinkel
Lichtquelle	LED-FT-37W / 1050 mA - 2700 K
CRI	80
Netz	EVG
LEDs	1
Bemessungsleistung	42 W

Bemessungslichtstrom (lm)

LED Lumen	2419
Total Lumen	2419
Ta	25

Nominal Lichtstrom (lm)

LED Lumen	4565
Total Lumen	4565
Tc	25

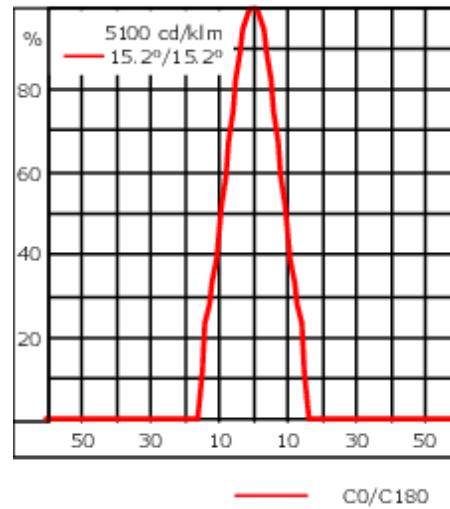

Spezifikationen

Materialbeschreibung

Gehäuse	Korrosionsbeständiger Aluminiumguss
Abdeckung	Sicherheitsglasscheibe
Farben	<div style="display: flex; flex-direction: column; gap: 5px;"> <div style="display: flex; align-items: center;"> <div style="width: 20px; height: 10px; background-color: black; margin-right: 5px;"></div> RAL9004 Signalschwarz </div> <div style="display: flex; align-items: center;"> <div style="width: 20px; height: 10px; background-color: #cccccc; margin-right: 5px;"></div> RAL9006 Weißaluminium </div> <div style="display: flex; align-items: center;"> <div style="width: 20px; height: 10px; background-color: #808080; margin-right: 5px;"></div> RAL9007 Graualuminium </div> <div style="display: flex; align-items: center;"> <div style="width: 20px; height: 10px; background-color: #333333; margin-right: 5px;"></div> RAL7016 Anthrazitgrau </div> <div style="display: flex; align-items: center;"> <div style="width: 20px; height: 10px; background-color: #e0e0e0; margin-right: 5px;"></div> RAL9016 Verkehrsweiß </div> </div>
Dichtung	CCG® Silikondichtung
Schrauben	PCS beschichtete Edelstahlschrauben
Schutzart	IP66
Schlagfestigkeit	IK07
Korrosionsbeständigkeit	5CE
Windangriffsfläche	0.06 m ²

Elektrische Beschreibung

Netz	220-240V / 50-60 Hz
Netzgerät / Vorschaltgerät	Standard. Variante mit DALI erhältlich, bei Bestellung bitte angeben.
Leistungsfaktor	> 0.9
Überspannungsschutz	6/6 kV (optional SP10)

WE-EF LEUCHTEN GmbH

Töpinger Straße 16, 29646 Bispingen, Germany - Tel: +49 5194 909-0

info.germany@we-ef.com - <https://we-ef.com/de>

Technische Änderungen und Irrtümer vorbehalten. - Erstellt am 23.11.2024

139-2511_max

FLC220 LED [ZP]

we-ef

Weitere Informationen

Lebensdauer Ta=25° L70B50 > 50000h

Energieeffizienzklasse F (Lichtquelle)

WE-EF LEUCHTEN GmbH

Töpinger Straße 16, 29646 Bispingen, Germany - Tel: +49 5194 909-0

info.germany@we-ef.com - <https://we-ef.com/de>

Technische Änderungen und Irrtümer vorbehalten. - Erstellt am 23.11.2024

Montagezubehör

Montagesockel EM

Beschreibung	Artikelnummer	D1	D2	H1	M1	Gewicht (kg)
EM1-M16	270-9038	160	130	200	9	2



Mastaufsatztraverse TA

Beschreibung	Artikelnummer	A	C1	D x L1	Gewicht (kg)	D x S
TA1 Mastaufsatztraverse, einfach (Ø 108 x 200)	147-0096		130	108 x 200	7.50	108 x 200



FLC220 LED [ZP]

Beschreibung	Artikelnummer	A	C1	D x L1	Gewicht (kg)	D x S
TA2 Mastaufsatztraverse, zweifach (Ø 108 x 200)	147-0097		130	108 x 200	7.50	108 x 200



TA2-L Mastaufsatztraverse, zweifach (Ø 76 x 200)	147-0105	±90°	420	76 x 200	16.10	76 x 200
--	----------	------	-----	----------	-------	----------

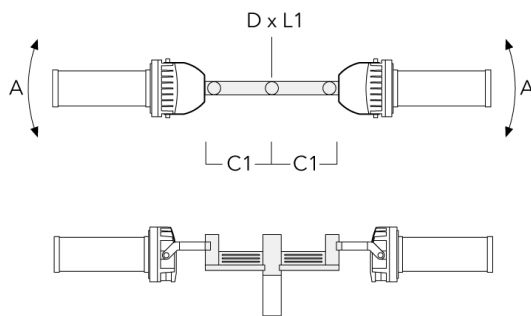

FLC220 LED [ZP]

Beschreibung	Artikelnummer	A	C1	D x L1	Gewicht (kg)	D x S
TA3 Mastaufsatztraverse, dreifach (Ø 89 x 200)	147-0025	±90°	650	89 x 200	17.90	89 x 200

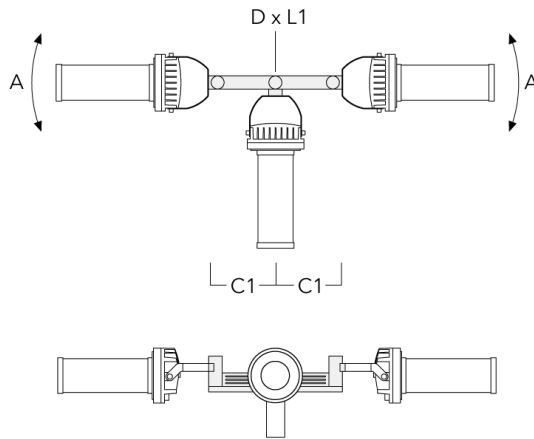

TA3 Mastaufsatztraverse, dreifach (Ø 108 x 200)	147-0098	±90°	650	108 x 200	24.20	108 x 200
---	----------	------	-----	-----------	-------	-----------



FLC220 LED [ZP]

Beschreibung	Artikelnummer	A	C1	D x L1	Gewicht (kg)	D x S
TA4 Mastaufsatztraverse, vierfach (Ø 89 x 200)	147-0099	±90°	650	89 x 200	20.80	89 x 200



TA4 Mastaufsatztraverse, vierfach (Ø 108 x 200)	147-0100	±90°	650	108 x 200	24.20	108 x 200
---	----------	------	-----	-----------	-------	-----------



Mastschelle TS

Beschreibung	Artikelnummer	D1	Gewicht (kg)	D
TS1-2/M12 Mastschelle, einfach (Ø 102-114)	147-0526	102-114	1.50	102-114

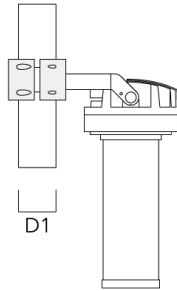
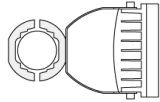

TS1-2/M12 Mastschelle, einfach (Ø 114-133)	147-0544	114-133	1.70	114-133
--	----------	---------	------	---------

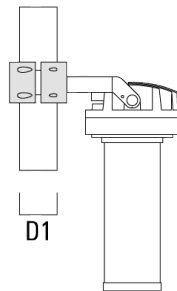
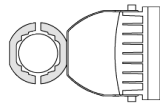

FLC220 LED [ZP]

Beschreibung	Artikelnummer	D1	Gewicht (kg)	D
TS2-2/M12 Mastschelle, zweifach (Ø 102-114)	147-0527	102-114	1.50	102-114

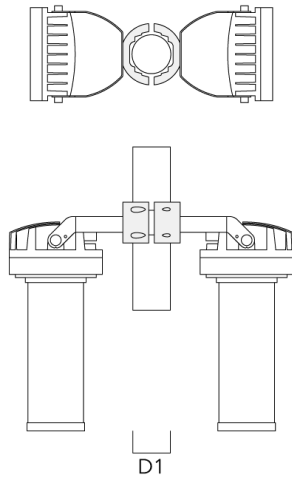

TS2-2/M12 Mastschelle, zweifach (Ø 76-89)	147-0545	76-89	1.40	76-89
---	----------	-------	------	-------



FLC220 LED [ZP]

Beschreibung	Artikelnummer	D1	Gewicht (kg)	D
TS2-2/M12 Mastschelle, zweifach (Ø 114-133)	147-0546	114-133	1.60	114-133



TS1-2/M12 Mastschelle, einfach (Ø 76-89)	147-0543	76-89	1.40	76-89
--	----------	-------	------	-------

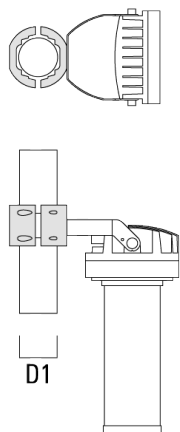

Mastschelle PC

Beschreibung	Artikelnummer	D1	Gewicht (kg)
PC1 76-89/60 Mastschelle, einfach (Ø 76-89)	139-2702	76-89	1.00



PC2 76-89/60 Mastschelle, zweifach (Ø 76-89)	139-2703	76-89	1.00
--	----------	-------	------



FLC220 LED [ZP]

Beschreibung	Artikelnummer	D1	Gewicht (kg)
PC1 82-109/60 Mastschelle, einfach (Ø 82-109)	139-2704	82-109	1.10

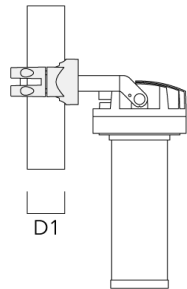
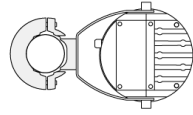

PC2 82-109/60 Mastschelle, zweifach (Ø 82-109)	139-2705	82-109	1.10
---	----------	--------	------

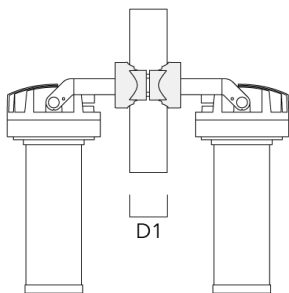

FLC220 LED [ZP]

Beschreibung	Artikelnummer	D1	Gewicht (kg)
PC1 102-114/60 Mast­schelle, einfach (Ø 102-114)	139-2706	102-114	1.20



PC2 102-114/60 Mast­schelle, zweifach (Ø 102-114)	139-2707	102-114	1.20
--	----------	---------	------



FLC220 LED [ZP]

Beschreibung	Artikelnummer	D1	Gewicht (kg)
PC1 114-133/60 Mastschelle, einfach (Ø 144-133)	139-2708	114-133	1.40

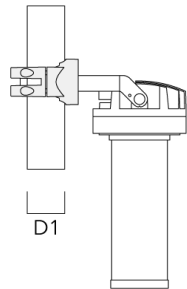

PC2 114-133/60 Mastschelle, zweifach (Ø 114-133)	139-2709	114-133	1.40
---	----------	---------	------



139-2511_max

FLC220 LED [ZP]

we-ef

Steuerung

R2C Ready to Connect

Beschreibung	Artikelnummer
R2C Ready to Connect (oben)	430-0019

WE-EF LEUCHTEN GmbH

Töpinger Straße 16, 29646 Bispingen, Germany - Tel: +49 5194 909-0

info.germany@we-ef.com - <https://we-ef.com/de>

Technische Änderungen und Irrtümer vorbehalten. - Erstellt am 23.11.2024