



Description

Profile Projector [ZP] for zoom spot. Spherical and aspherical, double flat convex lens system.

IP66, Class I. IK07. Marine-grade, die-cast aluminium alloy. 5CE superior corrosion protection including PCS hardware. Silicone CCG_R_ Controlled Compression Gasket. Safety glass lens. Two cable glands. Second gland for through wiring.

Integral EC electronic converter in thermally-separated compartment. Advanced thermal management protects LEDs while optimising lumens output.

Weight	8.20 kg
Light distribution	symmetric Zoom-Projector [ZP] - max aperture angle
Light source	LED-FT-37W / 1050 mA - 4000 K
CRI	80
Power supply	EC
LEDs	1
Rated input power	42 W
Rated lumens (lm)	
LED Lumen	2596.6
Total Lumen	2596.6
Ta	25
Nominal Lumen (lm)	
LED Lumen	4900
Total Lumen	4900
Tc	25

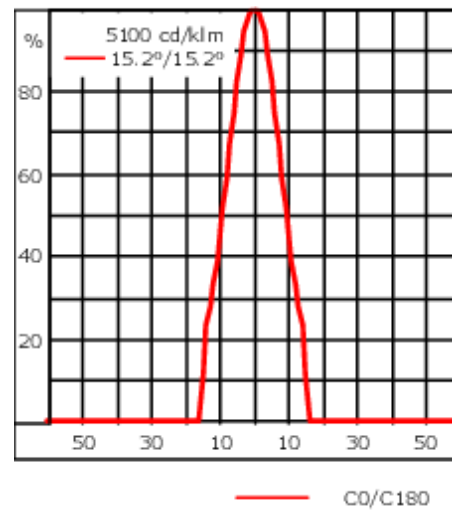

Specifications

Material description

Body	Marine-grade, die-cast aluminium alloy
Lens	Safety glass lens
Colours	<div style="display: flex; align-items: center;"> <div style="width: 20px; height: 15px; background-color: black; margin-right: 5px;"></div> <div>RAL9004 Signal black</div> </div> <div style="display: flex; align-items: center; margin-top: 5px;"> <div style="width: 20px; height: 15px; background-color: grey; margin-right: 5px;"></div> <div>RAL9007 Grey aluminium</div> </div> <div style="display: flex; align-items: center; margin-top: 5px;"> <div style="width: 20px; height: 15px; background-color: darkgrey; margin-right: 5px;"></div> <div>RAL7016 Anthracite grey</div> </div> <div style="display: flex; align-items: center; margin-top: 5px;"> <div style="width: 20px; height: 15px; background-color: lightgrey; margin-right: 5px;"></div> <div>RAL9016 Traffic white</div> </div>
Gasket	Silicone CCG® Controlled Compression Gasket
Fasteners	PCS Polymer Coated Stainless Steel Hardware
Ingress protection	IP66
Impact resistance	IK07
Corrosion resistance	5CE
Windage	0.06 m ²

Electrical description

Power supply	220-240V / 50-60 Hz
Driver / Ballast	Integral EC electronic converter in thermally-separated compartment
Power factor	> 0.9

Additional information

Lifetime	Ta=25° L70B50 > 50000h
----------	------------------------

WE-EF LIGHTING (Thailand) Co., Ltd.

57 Moo 5, Kingkaew Rd., Bangplee, 10540 Samutprakarn - Phone: +66 2 738 96 20 - Fax: +66 2 738 96 29

<https://we-ef.com/asia>

Subject to technical changes and errors. - Generated on 23/10/2024

Mounting Accessories

Short post

Description	Part ID	D1	D2	H1	M1	Weight (kg)
Short post EM1-M16	270-9038	160	130	200	9	2



Floodlight mounting bracket TA

Description	Part ID	A	C1	D x L1	Weight (kg)	D x S
TA1 Mounting bracket, single (Ø 108 x 200)	147-0096		130	108 x 200	7.50	108 x 200



FLC220 LED [ZP]

Description	Part ID	A	C1	D × L1	Weight (kg)	D × S
TA2 Mounting bracket, double (Ø 108 x 200)	147-0097		130	108 x 200	7.50	108 x 200



TA2-L Mounting bracket, double (Ø 76 x 200)	147-0105	±90°	420	76 x 200	16.10	76 x 200
---	----------	------	-----	----------	-------	----------

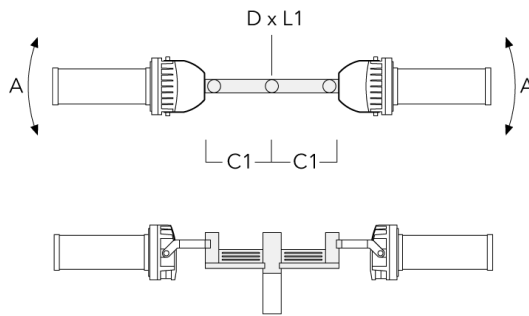

FLC220 LED [ZP]

Description	Part ID	A	C1	D × L1	Weight (kg)	D × S
TA3 Mounting bracket, triple (Ø 89 x 200)	147-0025	±90°	650	89 x 200	17.90	89 x 200



TA3 Mounting bracket, triple (Ø 108 x 200)	147-0098	±90°	650	108 x 200	24.20	108 x 200
--	----------	------	-----	-----------	-------	-----------



FLC220 LED [ZP]

Description	Part ID	A	C1	D x L1	Weight (kg)	D x S
TA4 Mounting bracket, quad (Ø 89 x 200)	147-0099	±90°	650	89 x 200	20.80	89 x 200



TA4 Mounting bracket, quad (Ø 108 x 200)	147-0100	±90°	650	108 x 200	24.20	108 x 200
--	----------	------	-----	-----------	-------	-----------



Planted root

WE-EF LIGHTING (Thailand) Co., Ltd.

57 Moo 5, Kingkaew Rd., Bangplee, 10540 Samutprakarn - Phone: +66 2 738 96 20 - Fax: +66 2 738 96 29

<https://we-ef.com/asia>

Subject to technical changes and errors. - Generated on 23/10/2024

FLC220 LED [ZP]

Description	Part ID	D1	D2	D3	D4	H1	H2	M1	T1	T2	Weight (kg)
Planted root ESV4	300-0461-AP	150	130	60	89	400	350	8	200	50 x 100	3.85



Spigot cap

Description	Part ID	D1	Weight (kg)
Spigot Cap KF1-M16 (ø 60 x 100)	310-9120	60 x 100	1.40

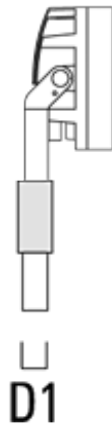

FLC220 LED [ZP]

Description	Part ID	D1	Weight (kg)
Spigot Cap KF1-M16 (ø 76 x 100)	310-9121	76 x 100	2.2



Pole clamp SP - Tiltable

Description	Part ID	D1	Weight (kg)	D
Pole clamp SP1-M16, single (Ø 76-89)	146-0242	76-89	1.30	76-89

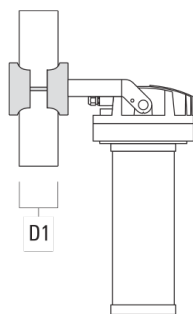

FLC220 LED [ZP]

Description	Part ID	D1	Weight (kg)	D
Pole clamp SP2-M16, double (Ø 76-89)	146-0244	76-89	1.50	

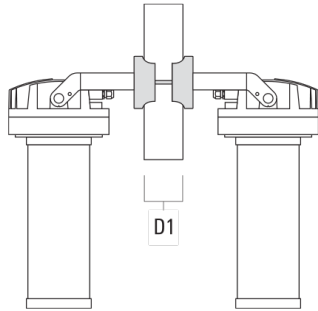

Pole clamp SP1-M16, single (Ø 38-60)	146-0241	38-60	1.30	
--------------------------------------	----------	-------	------	--

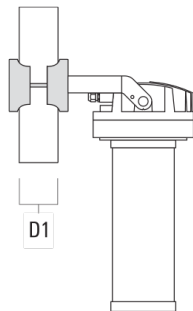

Pole clamp SP2-M16, double (Ø 38-60)	146-0243	38-60	1.50	
--------------------------------------	----------	-------	------	--

Pole clamp PC - Rotatable

WE-EF LIGHTING (Thailand) Co., Ltd.

57 Moo 5, Kingkaew Rd., Bangplee, 10540 Samutprakarn - Phone: +66 2 738 96 20 - Fax: +66 2 738 96 29

<https://we-ef.com/asia>

Subject to technical changes and errors. - Generated on 23/10/2024

FLC220 LED [ZP]

Description	Part ID	D1	Weight (kg)
PC1 76-89/60 Pole clamp, single (Ø 76-89)	139-2702	76-89	1.00

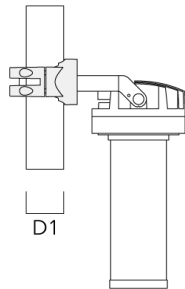

PC2 76-89/60 Pole clamp, double (Ø 76-89)	139-2703	76-89	1.00
---	----------	-------	------

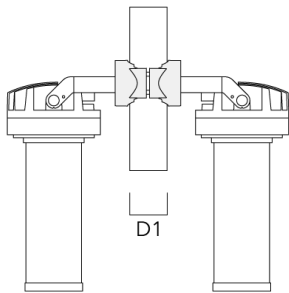

FLC220 LED [ZP]

Description	Part ID	D1	Weight (kg)
PC1 82-109/60 Pole clamp, single (Ø 82-109)	139-2704	82-109	1.10



PC2 82-109/60 Pole clamp, double (Ø 82-109)	139-2705	82-109	1.10
---	----------	--------	------



FLC220 LED [ZP]

Description	Part ID	D1	Weight (kg)
PC1 102-114/60 Pole clamp, single (Ø 102-114)	139-2706	102-114	1.20



PC2 102-114/60 Pole clamp, double (Ø 102-114)	139-2707	102-114	1.20
--	----------	---------	------



FLC220 LED [ZP]

Description	Part ID	D1	Weight (kg)
PC1 114-133/60 Pole clamp, single (Ø 114-133)	139-2708	114-133	1.40



PC2 114-133/60 Pole clamp, double (Ø 114-133)	139-2709	114-133	1.40
--	----------	---------	------



139-2123_max

FLC220 LED [ZP]

we-ef

Control

R2C Ready to Connect

Description	Part ID
R2C Ready to Connect (top)	430-0019

WE-EF LIGHTING (Thailand) Co., Ltd.

57 Moo 5, Kingkaew Rd., Bangplee, 10540 Samutprakarn - Phone: +66 2 738 96 20 - Fax: +66 2 738 96 29

<https://we-ef.com/asia>

Subject to technical changes and errors. - Generated on 23/10/2024

139-2123_max

FLC220 LED [ZP]

WE-EF LIGHTING (Thailand) Co., Ltd.

57 Moo 5, Kingkaew Rd., Bangplee, 10540 Samutprakarn

Phone: +66 2 738 96 20

Fax: +66 2 738 96 29

<https://we-ef.com/asia>

Subject to technical changes and errors.

Generated on 23/10/2024