



Description

Profile Projector [FP] for framing applications, polygon shape. Spherical and aspherical, double flat convex lens system. Tunable White Technology.

IP66, Class I. Class II on request. IK05. Marine-grade, die-cast aluminium alloy. 5CE superior corrosion protection including PCS hardware. Silicone CCG® Controlled Compression Gasket. Safety glass lens. One cable gland. Second gland for through wiring on request. Factory installed LED circuit board. Integral EC electronic converter in thermally-separated compartment. Glass LED lens array. DALI interface.

Weight	4 kg
Light distribution	symmetric Framing-Projector [FP] - min aperture angle
Light source	LED-FT-10W / 250mA - 2200-6000 K
CRI	80
Power supply	EC
LEDs	1
Rated input power	12 W

Rated lumens (lm)

LED Lumen	343.1
Total Lumen	343.1
Ta	25

Nominal Lumen (lm)

LED Lumen	1440
Total Lumen	1440
Tc	25

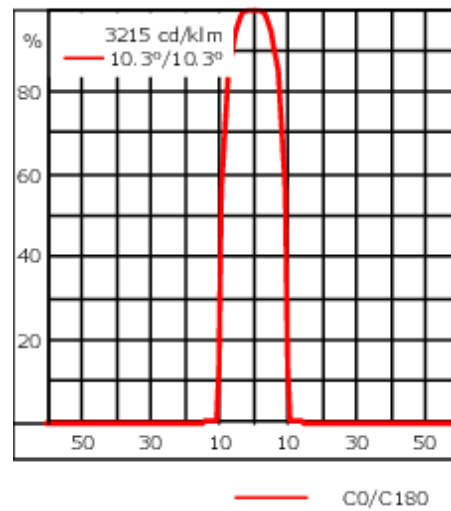

Specifications

Material description

Body	Marine-grade, die-cast aluminium alloy
Lens	Safety glass lens
Colours	<ul style="list-style-type: none"> RAL9004 Signal black RAL9006 White aluminium RAL9007 Grey aluminium RAL7016 Anthracite grey RAL9016 Traffic white
Gasket	Silicone CCG® Controlled Compression Gasket
Fasteners	PCS Polymer Coated Stainless Steel Hardware
Ingress protection	IP66
Impact resistance	IK05
Corrosion resistance	5CE

Electrical description

Power supply	220-240V / 50-60 Hz
Driver / Ballast	DALI (separate gearbox)
Power factor	> 0.9
Surge protection	6/6 kV (optional SP10 in separate gearbox, large)

Fagerhult Lighting Ltd

33-34 Dolben Street, SE1 0UQ London, United Kingdom

<https://we-ef.com/uk>

Subject to technical changes and errors. - Generated on 23/10/2024

139-2494_min

FLC210-TW LED [FP]

we-ef

Additional information

Lifetime Ta=25° L70B50 > 50000h

Energy efficiency class E (Light source)

Fagerhult Lighting Ltd

33-34 Dolben Street, SE1 0UQ London, United Kingdom

<https://we-ef.com/uk>

Subject to technical changes and errors. - Generated on 23/10/2024

Electrical Accessories

Gear box

Description	Part ID	A	B	C1	C2	Weight (kg)
GB200 R200x120 gear box (medium)	139-2526	75	120	229	200	1.05

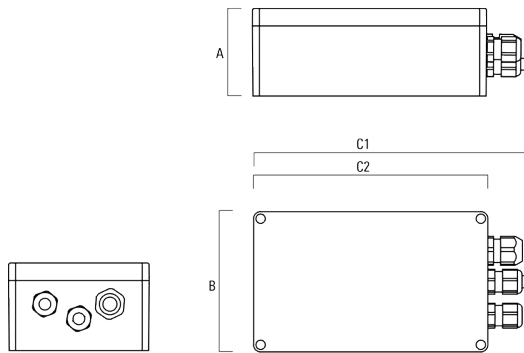

GB200 R230x140 gear box (large)	139-2527	95	140	259	230	1.20
---------------------------------	----------	----	-----	-----	-----	------

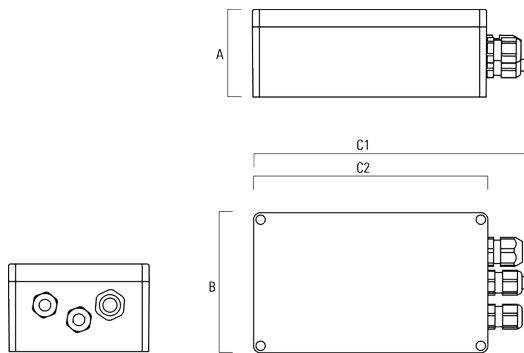

Mounting Accessories

Pole clamp PC

Description	Part ID	D1	Weight (kg)
PC1 76-89/60 Pole clamp, single (Ø 76-89)	139-2702	76-89	1.00

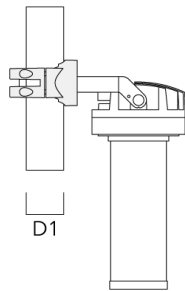
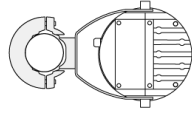

PC2 76-89/60 Pole clamp, double (Ø 76-89)	139-2703	76-89	1.00
---	----------	-------	------

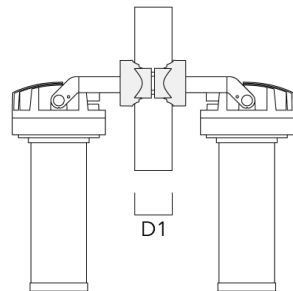
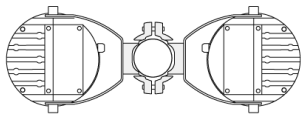

FLC210-TW LED [FP]

Description	Part ID	D1	Weight (kg)
PC2 82-109/60 Pole clamp, double (Ø 82-109)	139-2705	82-109	1.10



PC1 102-114/60 Pole clamp, single (Ø 102-114)	139-2706	102-114	1.20
--	----------	---------	------

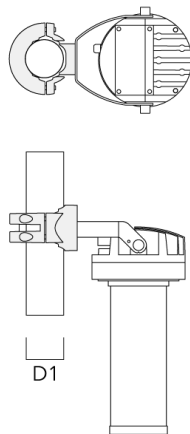

FLC210-TW LED [FP]

Description	Part ID	D1	Weight (kg)
PC2 102-114/60 Pole clamp, double (Ø 102-114)	139-2707	102-114	1.20

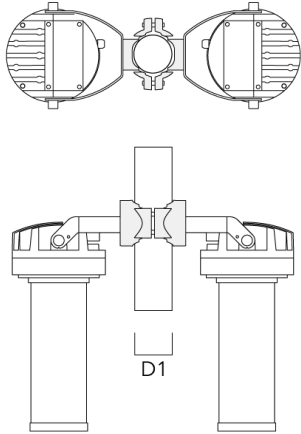

PC1 114-133/60 Pole clamp, single (Ø 114-133)	139-2708	114-133	1.40
--	----------	---------	------

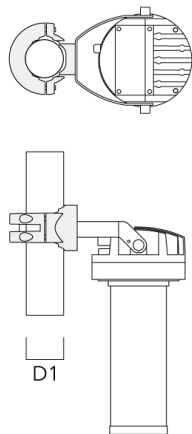

FLC210-TW LED [FP]

Description	Part ID	D1	Weight (kg)
PC2 114-133/60 Pole clamp, double (Ø 114-133)	139-2709	114-133	1.40

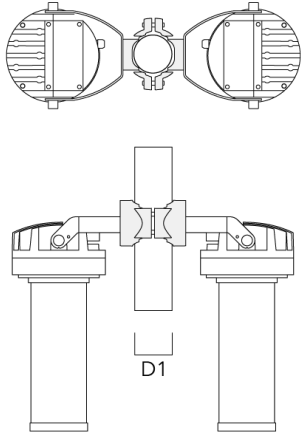

139-2494_min
FLC210-TW LED [FP]

Fagerhult Lighting Ltd

33-34 Dolben Street, SE1 0UQ London, United Kingdom

<https://we-ef.com/uk>

Subject to technical changes and errors.
Generated on 23/10/2024