

## FLC210 TW LED [FP] TUNABLE WHITE FRAMING PROJECTOR

**Description**

Tunable White Profile Projector [FP] for framing applications, polygon shape. Spherical and aspherical, double flat convex lens system.

IP66, Class I. IK05. Marine-grade, die-cast aluminum alloy. 5CE superior corrosion protection including PCS hardware. Silicone CCG® Controlled Compression Gasket. Safety glass lens. One cable gland. Second gland for through wiring on request. Integral driver in thermally separated compartment. OLC® One LED Concept. Factory installed LED circuit board. Tunable White technology. DMX interface.

Specify product with 7 Digit product code - Finish Color. Accessories, such as mounting, optical, and electrical, must be specified separately.

Example: XXX-XXXX - 9004 (Black)  
+ XXX-XXXX (Accessory 1)

|                           |                                                       |
|---------------------------|-------------------------------------------------------|
| Weight                    | 8.80 lb                                               |
| Light distribution        | symmetric Framing-Projector [FP] - min aperture angle |
| Light source              | LED-FT-10W / 250mA - 2200-6000 K                      |
| CRI                       | 80                                                    |
| Power supply              | electronic gear                                       |
| LEDs                      | 1                                                     |
| Rated input power         | 12 W                                                  |
| <b>Rated lumens (lm)</b>  |                                                       |
| LED Lumen                 | 343.1                                                 |
| Total Lumen               | 343.1                                                 |
| Ta                        | 25                                                    |
| <b>Nominal Lumen (lm)</b> |                                                       |
| LED Lumen                 | 1440                                                  |
| Total Lumen               | 1440                                                  |
| Tc                        | 25                                                    |

**WE-EF LIGHTING USA, LLC**

410-D Keystone Drive, 15086 Warrendale, PA 15086 - Phone: +1 724 742 0030  
customersupport.usa@we-ef.com - <https://we-ef.com/us>  
Subject to technical changes and errors. - Generated on 11/23/2024

## FLC210 TW LED [FP] TUNABLE WHITE FRAMING PROJECTOR

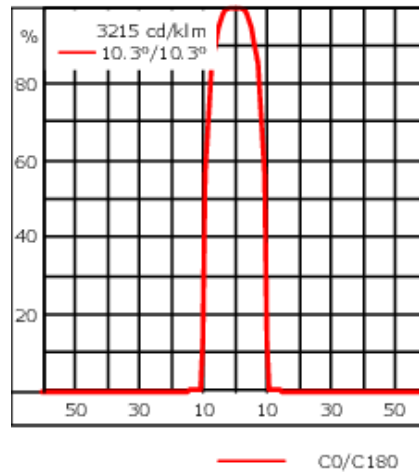
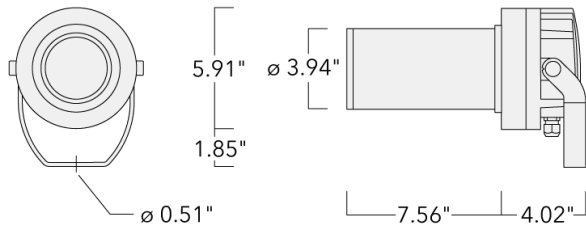

## Specifications

### Material description

|                      |                                                                                                                                                                                                                                                                                                                                                                                                                                                                                                                                                                                                                                                                                                                                                                                                                   |
|----------------------|-------------------------------------------------------------------------------------------------------------------------------------------------------------------------------------------------------------------------------------------------------------------------------------------------------------------------------------------------------------------------------------------------------------------------------------------------------------------------------------------------------------------------------------------------------------------------------------------------------------------------------------------------------------------------------------------------------------------------------------------------------------------------------------------------------------------|
| Body                 | Marine-grade, die-cast aluminium alloy                                                                                                                                                                                                                                                                                                                                                                                                                                                                                                                                                                                                                                                                                                                                                                            |
| Lens                 | Safety glass lens                                                                                                                                                                                                                                                                                                                                                                                                                                                                                                                                                                                                                                                                                                                                                                                                 |
| Colors               | <div style="display: flex; flex-direction: column; gap: 5px;"> <div style="display: flex; align-items: center;"> <div style="width: 20px; height: 15px; background-color: black; margin-right: 5px;"></div> <span>RAL9004 Black</span> </div> <div style="display: flex; align-items: center;"> <div style="width: 20px; height: 15px; background-color: grey; margin-right: 5px;"></div> <span>RAL9007 Grey Metallic</span> </div> <div style="display: flex; align-items: center;"> <div style="width: 20px; height: 15px; background-color: white; margin-right: 5px;"></div> <span>RAL9016 White</span> </div> <div style="display: flex; align-items: center;"> <div style="width: 20px; height: 15px; background-color: darkgrey; margin-right: 5px;"></div> <span>RAL8019 Dark Bronze</span> </div> </div> |
| Gasket               | Silicone CCG® Controlled Compression Gasket                                                                                                                                                                                                                                                                                                                                                                                                                                                                                                                                                                                                                                                                                                                                                                       |
| Fasteners            | PCS Polymer Coated Stainless Steel Hardware                                                                                                                                                                                                                                                                                                                                                                                                                                                                                                                                                                                                                                                                                                                                                                       |
| Ingress protection   | IP66                                                                                                                                                                                                                                                                                                                                                                                                                                                                                                                                                                                                                                                                                                                                                                                                              |
| Impact resistance    | IK05                                                                                                                                                                                                                                                                                                                                                                                                                                                                                                                                                                                                                                                                                                                                                                                                              |
| Corrosion resistance | 5CE                                                                                                                                                                                                                                                                                                                                                                                                                                                                                                                                                                                                                                                                                                                                                                                                               |

### Electrical description

|                  |                        |
|------------------|------------------------|
| Driver / Ballast | DMX (separate gearbox) |
| Power factor     | > 0.9                  |

#### WE-EF LIGHTING USA, LLC

410-D Keystone Drive, 15086 Warrendale, PA 15086 - Phone: +1 724 742 0030

customersupport.usa@we-ef.com - <https://we-ef.com/us>

Subject to technical changes and errors. - Generated on 11/23/2024

139-2494\_min

**we-ef**

**FLC210 TW LED [FP] TUNABLE WHITE FRAMING PROJECTOR**

**Additional information**

---

Lifetime Ta=25°/40° L70B50 > 50000h

Listings ETL, UL-1598, CSA-C22.2#250.0. Suitable for Wet Locations.

---

**WE-EF LIGHTING USA, LLC**

410-D Keystone Drive, 15086 Warrendale, PA 15086 - Phone: +1 724 742 0030  
customersupport.usa@we-ef.com - <https://we-ef.com/us>

Subject to technical changes and errors. - Generated on 11/23/2024

**FLC210 TW LED [FP] TUNABLE WHITE FRAMING PROJECTOR**

**Electrical Accessories**

**Gear box**

| Description                                         | Part ID  | A    | B    | C1   | C2   | Weight (lb) |
|-----------------------------------------------------|----------|------|------|------|------|-------------|
| GB200 R200x120 gear box<br>(medium) 120-277V, 0-10V | 139-2526 | 2.95 | 4.72 | 9.02 | 7.87 | 1.05        |

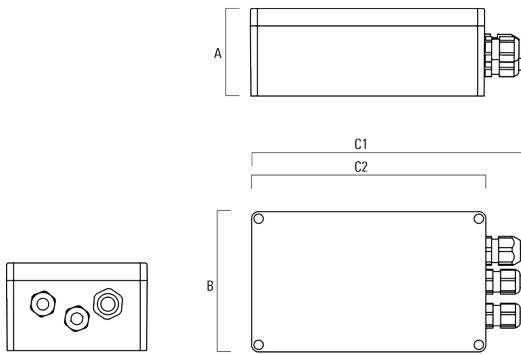

|                                 |          |    |     |     |     |      |
|---------------------------------|----------|----|-----|-----|-----|------|
| GB200 R230x140 gear box (large) | 139-2527 | 95 | 140 | 259 | 230 | 1.20 |
|---------------------------------|----------|----|-----|-----|-----|------|

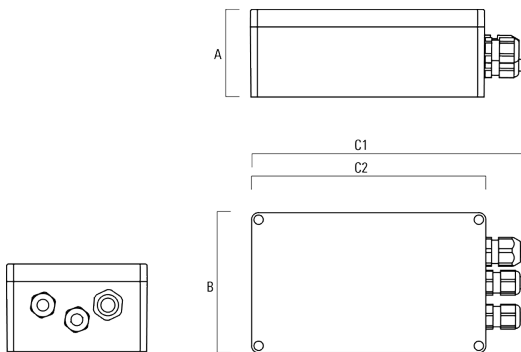

**WE-EF LIGHTING USA, LLC**

410-D Keystone Drive, 15086 Warrendale, PA 15086 - Phone: +1 724 742 0030  
 customersupport.usa@we-ef.com - <https://we-ef.com/us>

Subject to technical changes and errors. - Generated on 11/23/2024

**FLC210 TW LED [FP] TUNABLE WHITE FRAMING PROJECTOR**

| Description                       | Part ID  | A | B   | C1 | C2  | Weight (lb) |
|-----------------------------------|----------|---|-----|----|-----|-------------|
| FLC201_210 Tunable White Gear Box | 139-6978 | 3 | 4.7 | 9  | 7.9 |             |

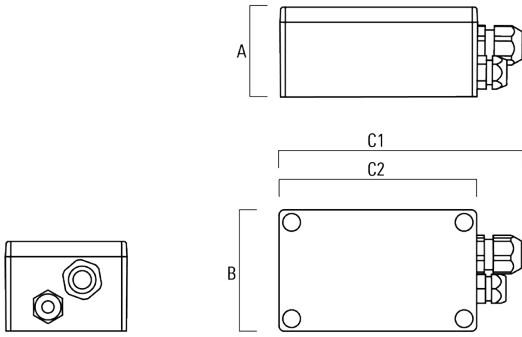

**WE-EF LIGHTING USA, LLC**

410-D Keystone Drive, 15086 Warrendale, PA 15086 - Phone: +1 724 742 0030  
customersupport.usa@we-ef.com - <https://we-ef.com/us>  
Subject to technical changes and errors. - Generated on 11/23/2024

**FLC210 TW LED [FP] TUNABLE WHITE FRAMING PROJECTOR**

**Mounting Accessories**

**Pole clamp PC**

| Description                                 | Part ID  | D1       | Weight (lb) |
|---------------------------------------------|----------|----------|-------------|
| PC1 76-89/60 Pole clamp, single (Ø 3"-3.5") | 139-2702 | 3.0-3.50 | 2.20        |

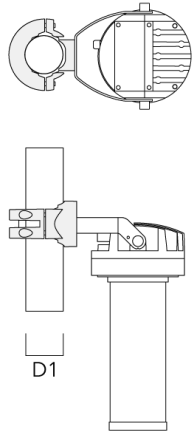

|                                             |          |          |      |
|---------------------------------------------|----------|----------|------|
| PC2 76-89/60 Pole clamp, double (Ø 3"-3.5") | 139-2703 | 3.0-3.50 | 2.20 |
|---------------------------------------------|----------|----------|------|

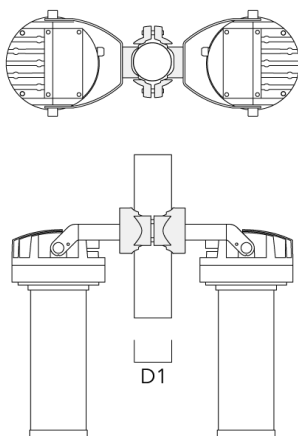

**WE-EF LIGHTING USA, LLC**

410-D Keystone Drive, 15086 Warrendale, PA 15086 - Phone: +1 724 742 0030

customersupport.usa@we-ef.com - <https://we-ef.com/us>

Subject to technical changes and errors. - Generated on 11/23/2024

**FLC210 TW LED [FP] TUNABLE WHITE FRAMING PROJECTOR**

| Description                                         | Part ID  | D1        | Weight (lb) |
|-----------------------------------------------------|----------|-----------|-------------|
| PC2 82-109/60 Pole clamp, double<br>(Ø 3.25"-4.25") | 139-2705 | 3.20-4.30 | 2.40        |

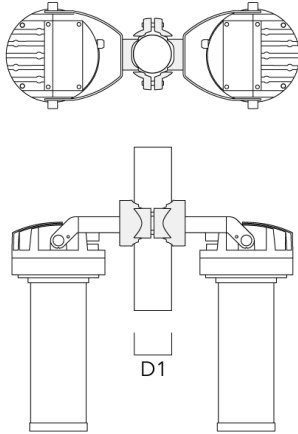

|                                                  |          |          |      |
|--------------------------------------------------|----------|----------|------|
| PC1 102-114/60 Pole clamp, single<br>(Ø 4"-4,5") | 139-2706 | 4.0-4.50 | 2.65 |
|--------------------------------------------------|----------|----------|------|

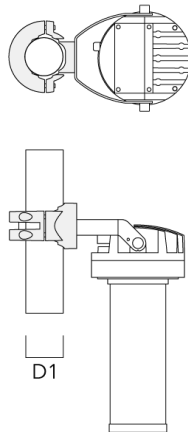

**WE-EF LIGHTING USA, LLC**

410-D Keystone Drive, 15086 Warrendale, PA 15086 - Phone: +1 724 742 0030  
 customersupport.usa@we-ef.com - <https://we-ef.com/us>  
 Subject to technical changes and errors. - Generated on 11/23/2024

**FLC210 TW LED [FP] TUNABLE WHITE FRAMING PROJECTOR**

| Description                                      | Part ID  | D1       | Weight (lb) |
|--------------------------------------------------|----------|----------|-------------|
| PC2 102-114/60 Pole clamp, double<br>(Ø 4"-4.5") | 139-2707 | 4.0-4.50 | 2.65        |



|                                                     |          |          |      |
|-----------------------------------------------------|----------|----------|------|
| PC1 114-133/60 Pole clamp, single<br>(Ø 4.5"-5.25") | 139-2708 | 4.5-5.25 | 3.10 |
|-----------------------------------------------------|----------|----------|------|

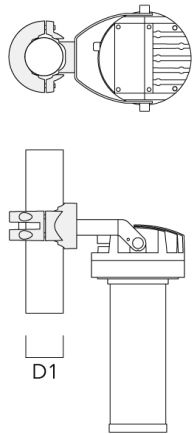

**WE-EF LIGHTING USA, LLC**

410-D Keystone Drive, 15086 Warrendale, PA 15086 - Phone: +1 724 742 0030  
 customersupport.usa@we-ef.com - <https://we-ef.com/us>  
 Subject to technical changes and errors. - Generated on 11/23/2024



**FLC210 TW LED [FP] TUNABLE WHITE FRAMING PROJECTOR**

---

| Description                                         | Part ID  | D1       | Weight (lb) |
|-----------------------------------------------------|----------|----------|-------------|
| PC2 114-133/60 Pole clamp, double<br>(Ø 4.5"-5.25") | 139-2709 | 4.5-5.25 | 3.10        |

---

