

## FLC210-CC LED [ZP] COLOR CHANGING ZOOM SPOT PROJECTOR

**Description**

RGBW/RGBA Color Changer Profile Projector [ZP] for zoom spot. Spherical and aspherical, double flat convex lens system.

IP66, Class III. IK05. Marine-grade, die-cast aluminum alloy. 5CE superior corrosion protection including PCS hardware. Silicone CCG® Controlled Compression Gasket. Safety glass lens. One cable gland. Second gland for through wiring on request. Integral driver in separate driver box (medium), prewired. OLC® One LED Concept. Factory installed LED circuit board. Color Changer technology. DMX interface.

Specify product with 7 Digit product code - Finish Color. Accessories, such as mounting, optical, and electrical, must be specified separately.

Example: XXX-XXXX - 9004 (Black)  
+ XXX-XXXX (Accessory 1)

Weight	8.80 lb
Light distribution	symmetric Zoom-Projector [ZP] - min aperture angle
Light source	LED-FT-15W - RGBW/4K
CRI	20/80
Power supply	electronic gear
LEDs	1
Rated input power	17 W
<b>Rated lumens (lm)</b>	
LED Lumen	333.5
Total Lumen	333.5
Ta	25
<b>Nominal Lumen (lm)</b>	
LED Lumen	1400
Total Lumen	1400
Tc	25

**WE-EF LIGHTING USA, LLC**

410-D Keystone Drive, 15086 Warrendale, PA 15086 - Phone: +1 724 742 0030  
customersupport.usa@we-ef.com - <https://we-ef.com/us>  
Subject to technical changes and errors. - Generated on 11/23/2024

## FLC210-CC LED [ZP] COLOR CHANGING ZOOM SPOT PROJECTOR

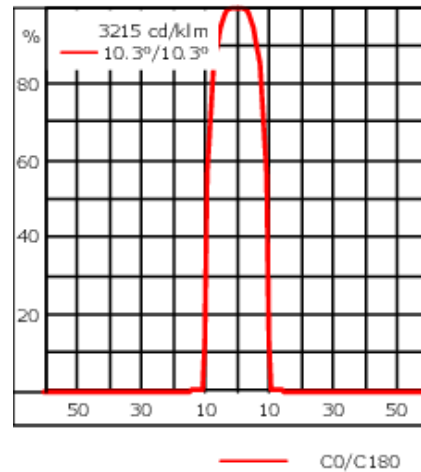
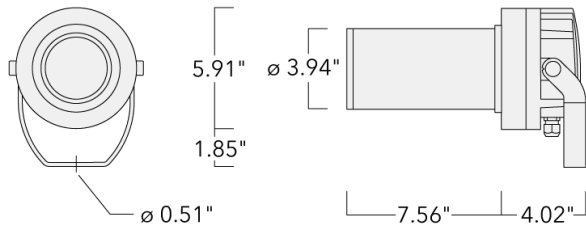

## Specifications

### Material description

Body	Marine-grade, die-cast aluminium alloy
Lens	Safety glass lens
Colors	<div style="display: flex; flex-direction: column; gap: 5px;"> <div style="display: flex; align-items: center;"> <div style="width: 20px; height: 15px; background-color: black; margin-right: 5px;"></div> <span>RAL9004 Black</span> </div> <div style="display: flex; align-items: center;"> <div style="width: 20px; height: 15px; background-color: grey; margin-right: 5px;"></div> <span>RAL9007 Grey Metallic</span> </div> <div style="display: flex; align-items: center;"> <div style="width: 20px; height: 15px; background-color: white; margin-right: 5px;"></div> <span>RAL9016 White</span> </div> <div style="display: flex; align-items: center;"> <div style="width: 20px; height: 15px; background-color: darkgrey; margin-right: 5px;"></div> <span>RAL8019 Dark Bronze</span> </div> </div>
Gasket	Silicone CCG® Controlled Compression Gasket
Fasteners	PCS Polymer Coated Stainless Steel Hardware
Ingress protection	IP66
Impact resistance	IK05
Corrosion resistance	5CE

### Electrical description

Driver / Ballast	DMX (separate gearbox)
Power factor	> 0.9

#### WE-EF LIGHTING USA, LLC

410-D Keystone Drive, 15086 Warrendale, PA 15086 - Phone: +1 724 742 0030

customersupport.usa@we-ef.com - <https://we-ef.com/us>

Subject to technical changes and errors. - Generated on 11/23/2024

139-2484\_min

**we-ef**

**FLC210-CC LED [ZP] COLOR CHANGING ZOOM SPOT PROJECTOR**

**Additional information**

---

Lifetime	Ta=25°/40° L70B50 > 50000h
Listings	ETL, UL-1598, CSA-C22.2#250.0. Suitable for Wet Locations.

---

**WE-EF LIGHTING USA, LLC**

410-D Keystone Drive, 15086 Warrendale, PA 15086 - Phone: +1 724 742 0030  
customersupport.usa@we-ef.com - <https://we-ef.com/us>  
Subject to technical changes and errors. - Generated on 11/23/2024

**FLC210-CC LED [ZP] COLOR CHANGING ZOOM SPOT PROJECTOR**

**Electrical Accessories**

**Gear box**

Description	Part ID	A	B	C1	C2	Weight (lb)
GB200 R200x120 gear box (medium) 120-277V, 0-10V	139-2526	2.95	4.72	9.02	7.87	1.05

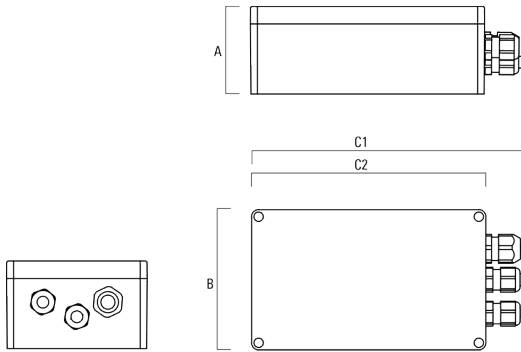

GB200 R230x140 gear box (large)	139-2527	95	140	259	230	1.20
---------------------------------	----------	----	-----	-----	-----	------

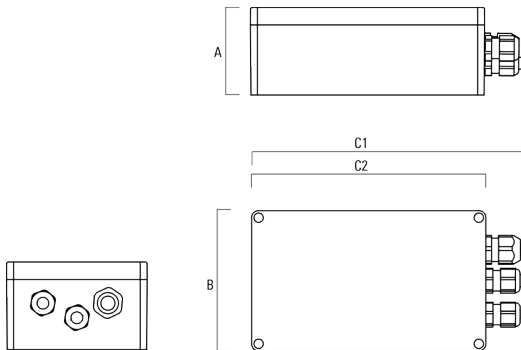

**WE-EF LIGHTING USA, LLC**

410-D Keystone Drive, 15086 Warrendale, PA 15086 - Phone: +1 724 742 0030  
 customersupport.usa@we-ef.com - <https://we-ef.com/us>

Subject to technical changes and errors. - Generated on 11/23/2024

**FLC210-CC LED [ZP] COLOR CHANGING ZOOM SPOT PROJECTOR**

Description	Part ID	A	B	C1	C2	Weight (lb)
FLC210 RGBW Gear Box	139-6979	3	4.7	9	7.9	

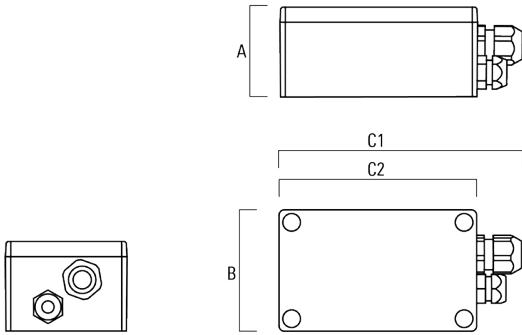

**WE-EF LIGHTING USA, LLC**

410-D Keystone Drive, 15086 Warrendale, PA 15086 - Phone: +1 724 742 0030

customersupport.usa@we-ef.com - <https://we-ef.com/us>

Subject to technical changes and errors. - Generated on 11/23/2024

## FLC210-CC LED [ZP] COLOR CHANGING ZOOM SPOT PROJECTOR

## Mounting Accessories

## Pole clamp PC

Description	Part ID	D1	Weight (lb)
PC1 76-89/60 Pole clamp, single (Ø 3"-3.5")	139-2702	3.0-3.50	2.20

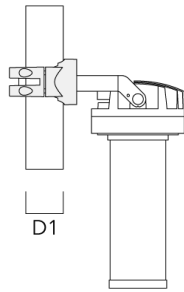
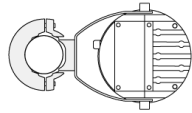

PC2 76-89/60 Pole clamp, double (Ø 3"-3.5")	139-2703	3.0-3.50	2.20
---	----------	----------	------

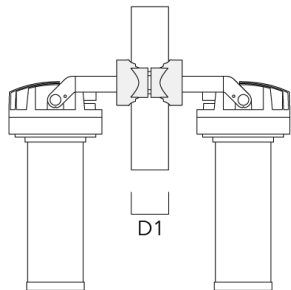
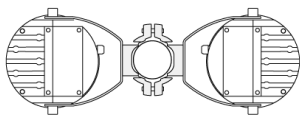

## WE-EF LIGHTING USA, LLC

410-D Keystone Drive, 15086 Warrendale, PA 15086 - Phone: +1 724 742 0030  
 customersupport.usa@we-ef.com - <https://we-ef.com/us>

Subject to technical changes and errors. - Generated on 11/23/2024

**FLC210-CC LED [ZP] COLOR CHANGING ZOOM SPOT PROJECTOR**

Description	Part ID	D1	Weight (lb)
PC2 82-109/60 Pole clamp, double (Ø 3.25"-4.25")	139-2705	3.20-4.30	2.40



PC1 102-114/60 Pole clamp, single (Ø 4"-4,5")	139-2706	4.0-4.50	2.65
--	----------	----------	------

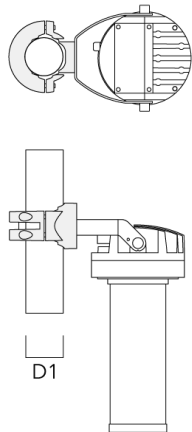

**WE-EF LIGHTING USA, LLC**

410-D Keystone Drive, 15086 Warrendale, PA 15086 - Phone: +1 724 742 0030  
 customersupport.usa@we-ef.com - <https://we-ef.com/us>  
 Subject to technical changes and errors. - Generated on 11/23/2024

**FLC210-CC LED [ZP] COLOR CHANGING ZOOM SPOT PROJECTOR**

Description	Part ID	D1	Weight (lb)
PC2 102-114/60 Pole clamp, double (Ø 4"-4.5")	139-2707	4.0-4.50	2.65



PC1 114-133/60 Pole clamp, single (Ø 4.5"-5.25")	139-2708	4.5-5.25	3.10
---	----------	----------	------

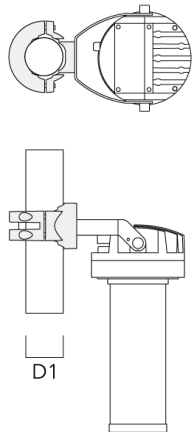

**WE-EF LIGHTING USA, LLC**

410-D Keystone Drive, 15086 Warrendale, PA 15086 - Phone: +1 724 742 0030  
 customersupport.usa@we-ef.com - <https://we-ef.com/us>  
 Subject to technical changes and errors. - Generated on 11/23/2024



## FLC210-CC LED [ZP] COLOR CHANGING ZOOM SPOT PROJECTOR

Description	Part ID	D1	Weight (lb)
PC2 114-133/60 Pole clamp, double (Ø 4.5"-5.25")	139-2709	4.5-5.25	3.10

**WE-EF LIGHTING USA, LLC**

410-D Keystone Drive, 15086 Warrendale, PA 15086 - Phone: +1 724 742 0030  
customersupport.usa@we-ef.com - <https://we-ef.com/us>  
Subject to technical changes and errors. - Generated on 11/23/2024