



Description

RGBW/RGBA Colour Changer Profile Projector [GP] for projection of gobos on a surface. Spherical and aspherical, double flat convex lens system. Gobo motif on request, to be ordered separately.

IP66, Class III. IK05. Marine-grade, die-cast aluminium alloy. 5CE superior corrosion protection including PCS hardware. Silicone CCG® Controlled Compression Gasket. Safety glass lens. One cable gland. Second gland for through wiring on request. Electronic control gear in separate gearbox (medium), prewired. Glass LED lens array. Factory installed LED circuit board. DMX interface.

Gobo outside diameter 46.6 mm, max. printable area d = 38 mm.

Weight	4.00 kg
Light distribution	symmetric Gobo-Projector [GP] - min aperture angle
Light source	LED-FT-15W - RGBA
CRI	20
Power supply	EC
LEDs	1
Rated input power	17 W
Rated lumens (lm)	
LED Lumen	151.5
Total Lumen	151.5
Ta	25
Nominal Lumen (lm)	
LED Lumen	1200
Total Lumen	1200
Tc	25

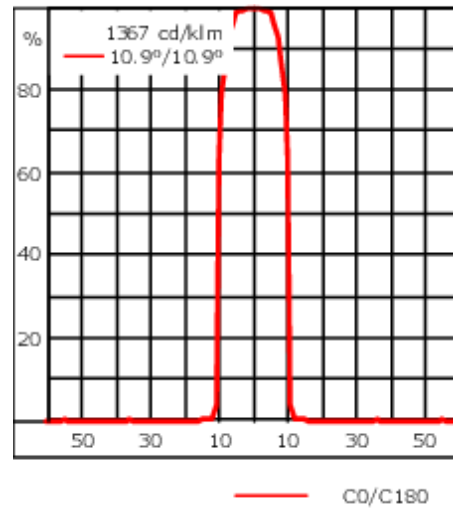

Specifications

Material description

Body	Marine-grade, die-cast aluminium alloy
Lens	Safety glass lens
Colours	<div style="display: flex; align-items: center;"> <div style="width: 20px; height: 15px; background-color: black; margin-right: 5px;"></div> RAL9004 Signal black </div> <div style="display: flex; align-items: center; margin-top: 5px;"> <div style="width: 20px; height: 15px; background-color: #cccccc; margin-right: 5px;"></div> RAL9006 White aluminium </div> <div style="display: flex; align-items: center; margin-top: 5px;"> <div style="width: 20px; height: 15px; background-color: #808080; margin-right: 5px;"></div> RAL9007 Grey aluminium </div>
Gasket	Silicone CCG® Controlled Compression Gasket
Fasteners	PCS Polymer Coated Stainless Steel Hardware
Ingress protection	IP66
Impact resistance	IK05
Corrosion resistance	5CE

Electrical description

Driver / Ballast	DMX (separate gearbox)
Power factor	> 0.9

Additional information

Lifetime	Ta=40° L70B50 > 50000h
----------	------------------------

Electrical Accessories

Gear box

Description	Part ID	A	B	C1	C2	Weight (kg)
GB200 R200x120 gear box (medium)	139-2526	75	120	229	200	1.05

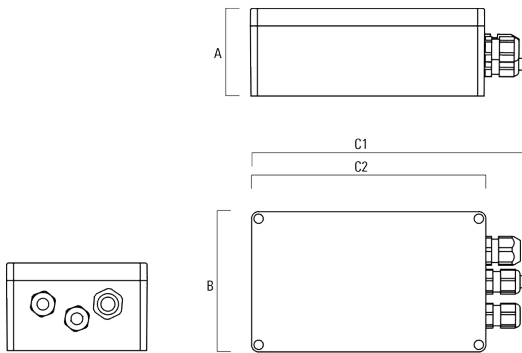

GB200 R230x140 gear box (large)	139-2527	95	140	259	230	1.20
---------------------------------	----------	----	-----	-----	-----	------

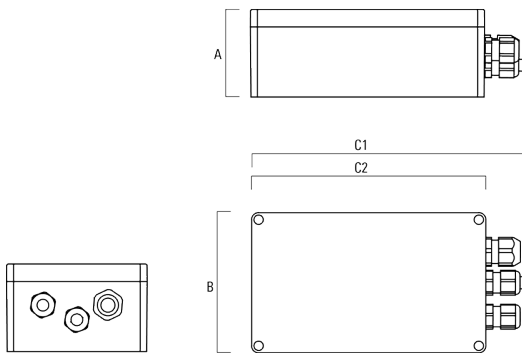

Mounting Accessories

Pole clamp PC - Rotatable

Description	Part ID	D1	Weight (kg)
PC1 76-89/60 Pole clamp, single (Ø 76-89)	139-2702	76-89	1.00

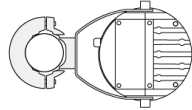

PC2 76-89/60 Pole clamp, double (Ø 76-89)	139-2703	76-89	1.00
---	----------	-------	------



FLC210-CC LED [GP]

Description	Part ID	D1	Weight (kg)
PC2 82-109/60 Pole clamp, double (Ø 82-109)	139-2705	82-109	1.10



PC1 102-114/60 Pole clamp, single (Ø 102-114)	139-2706	102-114	1.20
--	----------	---------	------



FLC210-CC LED [GP]

Description	Part ID	D1	Weight (kg)
PC2 102-114/60 Pole clamp, double (Ø 102-114)	139-2707	102-114	1.20



PC1 114-133/60 Pole clamp, single (Ø 114-133)	139-2708	114-133	1.40
--	----------	---------	------



FLC210-CC LED [GP]

Description	Part ID	D1	Weight (kg)
PC2 114-133/60 Pole clamp, double (Ø 114-133)	139-2709	114-133	1.40



139-2488_min

FLC210-CC LED [GP]

we-ef

Optical Accessories

Gobo cartridge

Description	Part ID
Gobo cartridge for FLC210 [GP]	139-2858

WE-EF LIGHTING Pty Ltd

6/13 Downard Street, 3195 Braeside, Victoria - Phone: +61 3 8587 0444 - Fax: +61 3 8587 0499

info.australia@we-ef.com - <https://we-ef.com/aus>

Subject to technical changes and errors. - Generated on 23/10/2024

139-2488_min
FLC210-CC LED [GP]

WE-EF LIGHTING Pty Ltd

6/13 Downard Street, 3195 Braeside, Victoria

Phone: +61 3 8587 0444

Fax: +61 3 8587 0499

info.australia@we-ef.com

<https://we-ef.com/aus>

Subject to technical changes and errors.

Generated on 23/10/2024