



Description

Projecteur LED à SPOT. Projection de forme ronde précise.

IP66. Classe I. Classe II sur demande. IK05. Corps en fonte d'aluminium. Visserie inox avec traitement PCS. Protection contre la corrosion 5CE. Joint silicone. Verre de sécurité. Circuit LED installé en usine. (Dé)montage facile sans dérégler le train optique. Une entrée de câble (seconde entrée en option, sur demande). Driver électronique séparé thermiquement, protection surtension 6/6kV intégrée.

Poids	4.00 kg
Distribution de la lumière	projecteur gobo découpe [FP] - angle d'ouverture max
Source lumineuse	LED-FT-18W - 2700 K
IRC	80
Alimentation électrique	ballast électronique
LEDs	1
Rated input power	20 W

Rated lumens (lm)

LED Lumen	1286.6
Total Lumen	1286.6
Ta	25

Flux lumineux nominal (lm)

LED Lumen	2320
Total Lumen	2320
Tc	25

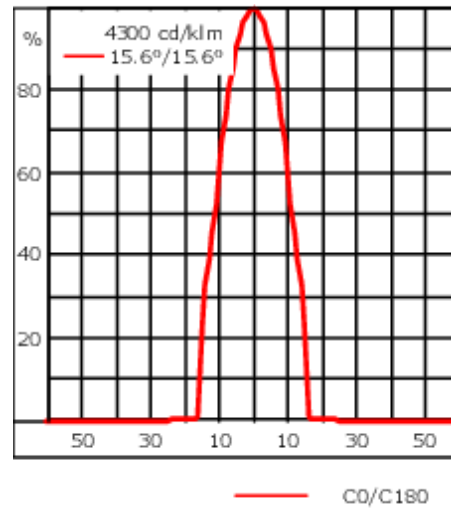

Spécifications

Description du matériel

Corps	Corps en fonte d'aluminium
Lentille	Verre de sécurité
Couleurs	<div style="display: flex; align-items: center; gap: 10px;"> <div style="width: 20px; height: 15px; background-color: black; margin-right: 5px;"></div> RAL9004 Noir de sécurité </div> <div style="display: flex; align-items: center; gap: 10px;"> <div style="width: 20px; height: 15px; background-color: #808080; margin-right: 5px;"></div> RAL9007 Aluminium gris </div> <div style="display: flex; align-items: center; gap: 10px;"> <div style="width: 20px; height: 15px; background-color: #333333; margin-right: 5px;"></div> RAL7016 Gris anthracite </div> <div style="display: flex; align-items: center; gap: 10px;"> <div style="width: 20px; height: 15px; background-color: #e0e0e0; margin-right: 5px;"></div> RAL9016 Blanc signalisation </div>
Joint	CCG® Joint silicone
Visserie	PCS Inox avec revêtement polymère
IP	IP66
IK	IK05
Protection contre la corrosion	5CE

Description électrique

Driver	Standard - version DALI disponible en option
Power factor	> 0.9

Informations complémentaires

Durée de vie	Ta=25° L70B50 > 50000h
Classe d'efficacité énergétique	F

WE-EF Switzerland AG

Himmelrichstrasse 6, 6003 Luzern - Téléphone: +41 22 752 49 94

info.switzerland@we-ef.com - https://we-ef.com/ch_fr

Sous réserve de modifications techniques et d'erreurs. - Généré le 23/11/2024

Accessoires d'installation

Collier pour mâts PC

Description	Référence	D1	Poids (kg)
PC1 76-89/60 collier simple (Ø 76-89)	139-2702	76-89	1.00

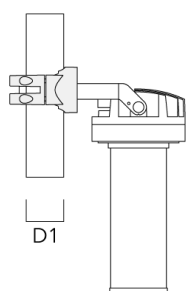
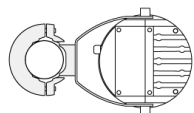

PC2 76-89/60 collier double pour tube (Ø 76-89)	139-2703	76-89	1.00
---	----------	-------	------

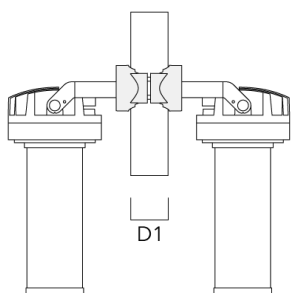
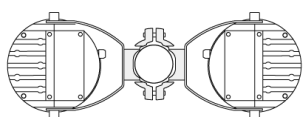

FLC210 LED [ZP]

Description	Référence	D1	Poids (kg)
PC2 82-109/60 collier double pour tube (Ø 82-109)	139-2705	82-109	1.10

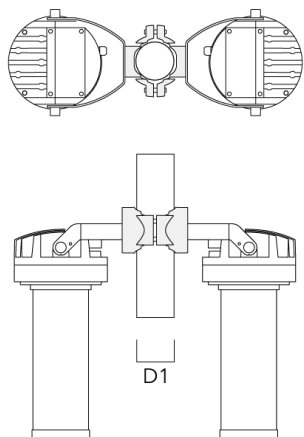

PC1 102-114/60 collier simple (Ø 102-114)	139-2706	102-114	1.20
---	----------	---------	------

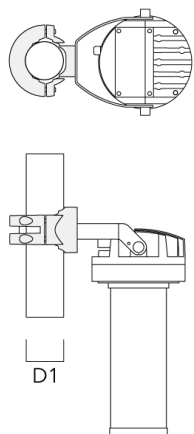

FLC210 LED [ZP]

Description	Référence	D1	Poids (kg)
PC2 102-114/60 collier double pour tube (Ø 102-114)	139-2707	102-114	1.20

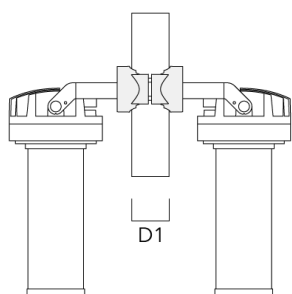
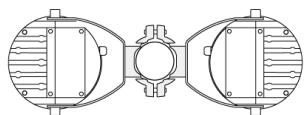

PC1 114-133/60 collier simple (Ø 144-133)	139-2708	114-133	1.40
---	----------	---------	------

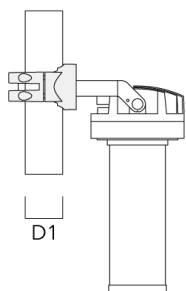
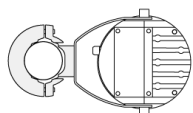

FLC210 LED [ZP]

Description	Référence	D1	Poids (kg)
PC2 114-133/60 collier double pour tube (Ø 114-133)	139-2709	114-133	1.40

