



Description

Profile Projector [FP] for framing applications, polygon shape. Spherical and aspherical, double flat convex lens system.

IP66, Class I. IK05. Marine-grade, die-cast aluminium alloy. 5CE superior corrosion protection including PCS hardware. Silicone CCG® Controlled Compression Gasket. Safety glass lens. One cable gland. Second gland for through wiring on request.

Integral EC electronic converter in thermally-separated compartment. Glass LED lens array. Factory installed LED circuit board.

Weight	4.00 kg
Light distribution	symmetric Framing-Projector [FP] - min aperture angle
Light source	LED-FT-18W - 3000 K
CRI	80
Power supply	EC
LEDs	1
Rated input power	20 W
Rated lumens (lm)	
LED Lumen	1231.4
Total Lumen	1231.4
Ta	25
Nominal Lumen (lm)	
LED Lumen	2400
Total Lumen	2400
Tc	25



Specifications

Material description

Body	Marine-grade, die-cast aluminium alloy
Lens	Safety glass lens
Colours	<div style="display: flex; align-items: center;"> <div style="width: 20px; height: 15px; background-color: black; margin-right: 5px;"></div> RAL9004 Signal black </div> <div style="display: flex; align-items: center; margin-top: 5px;"> <div style="width: 20px; height: 15px; background-color: grey; margin-right: 5px;"></div> RAL9007 Grey aluminium </div> <div style="display: flex; align-items: center; margin-top: 5px;"> <div style="width: 20px; height: 15px; background-color: darkgrey; margin-right: 5px;"></div> RAL7016 Anthracite grey </div> <div style="display: flex; align-items: center; margin-top: 5px;"> <div style="width: 20px; height: 15px; background-color: lightgrey; margin-right: 5px;"></div> RAL9016 Traffic white </div>
Gasket	Silicone CCG® Controlled Compression Gasket
Fasteners	PCS Polymer Coated Stainless Steel Hardware
Ingress protection	IP66
Impact resistance	IK05
Corrosion resistance	5CE

Electrical description

Driver / Ballast	Integral EC electronic converter in thermally-separated compartment
Power factor	> 0.9

Additional information

Lifetime	Ta=25° L70B50 > 50000h
----------	------------------------

Mounting Accessories

Pole clamp PC - Rotatable

Description	Part ID	D1	Weight (kg)
PC2 76-89/60 Pole clamp, double (Ø 76-89)	139-2703	76-89	1.00

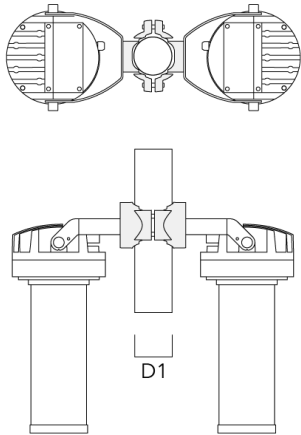

PC2 82-109/60 Pole clamp, double (Ø 82-109)	139-2705	82-109	1.10
---	----------	--------	------



FLC210 LED [FP]

Description	Part ID	D1	Weight (kg)
PC2 102-114/60 Pole clamp, double (Ø 102-114)	139-2707	102-114	1.20



PC1 114-133/60 Pole clamp, single (Ø 114-133)	139-2708	114-133	1.40
--	----------	---------	------



FLC210 LED [FP]

Description	Part ID	D1	Weight (kg)
PC2 114-133/60 Pole clamp, double (Ø 114-133)	139-2709	114-133	1.40



139-2475_min

FLC210 LED [FP]

WE-EF LIGHTING (Thailand) Co., Ltd.

57 Moo 5, Kingkaew Rd., Bangplee, 10540 Samutprakarn

Phone: +66 2 738 96 20

Fax: +66 2 738 96 29

<https://we-ef.com/asia>

Subject to technical changes and errors.

Generated on 23/10/2024