

111-0720

RFS530 LED

we-ef



Description

Catenary-mounted luminaire.

IP66. Class I. IK07. Marine-grade, die-cast aluminum alloy. 5CE superior corrosion protection including PCS hardware. Silicone CCG® Controlled Compression Gasket. Non-reflecting safety glass lens hinged. Cable inclination angle: Maximum 10°. Supplied with 3 ft of cable. CAD-optimized optics for superior illumination and glare control. Integral driver in thermally separated compartment. OLC® One LED Concept. Factory-installed LED circuit board. 0-10V Dimming comes standard with luminaire. Built-in surface junction box. Luminaire is factory-sealed and does not need to be opened during installation.

Rotatable 25°, tiltable 10° on the cable.

Specify product with 7 Digit product code - Finish Color. Accessories, such as mounting, optical, and electrical, must be specified separately.

Example: XXX-XXXX-9004 (Black)
+ XXX-XXXX (Accessory 1)

For DarkSky compliant configurations of this product,

Weight	26.20 lb
Light distribution	[S60] Type III Short
Light source	LED-24/24W/24W / 700 mA - 3000 K
CRI	80
Power supply	electronic gear
BUG	B2 U0 G2
LEDs	24
Rated input power	54 W

Nominal Lumen (lm)	
LED Lumen	290
Total Lumen	6960
Tj	85

Rated lumens (lm)	
LED Lumen	253.3
Total Lumen	6079.1
Ta	25

WE-EF LIGHTING USA, LLC

410-D Keystone Drive, 15086 Warrendale, PA 15086 - Phone: +1 724 742 0030
customersupport.usa@we-ef.com - <https://we-ef.com/us>
Subject to technical changes and errors. - Generated on 11/23/2024

111-0720

RFS530 LED

we-ef

please find the spec sheet and DarkSky certificate in the library.

WE-EF LIGHTING USA, LLC

410-D Keystone Drive, 15086 Warrendale, PA 15086 - Phone: +1 724 742 0030
customersupport.usa@we-ef.com - <https://we-ef.com/us>

Subject to technical changes and errors. - Generated on 11/23/2024

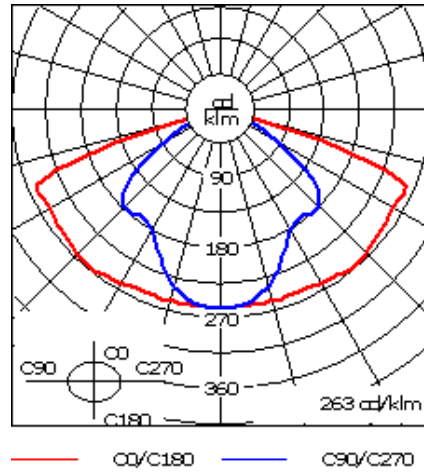
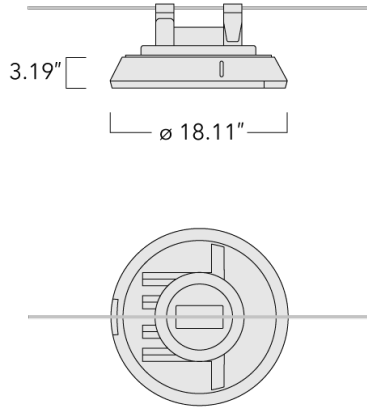

Specifications

Material description

Body	Marine-grade die-cast aluminium alloy
Lens	Non-reflecting safety glass lens, hinged
Colors	<div style="display: flex; flex-direction: column; gap: 5px;"> <div style="display: flex; align-items: center;"> <div style="width: 20px; height: 10px; background-color: black; margin-right: 5px;"></div> RAL9004 Black </div> <div style="display: flex; align-items: center;"> <div style="width: 20px; height: 10px; background-color: grey; margin-right: 5px;"></div> RAL9007 Grey Metallic </div> <div style="display: flex; align-items: center;"> <div style="width: 20px; height: 10px; background-color: white; margin-right: 5px;"></div> RAL9016 White </div> <div style="display: flex; align-items: center;"> <div style="width: 20px; height: 10px; background-color: darkgrey; margin-right: 5px;"></div> RAL8019 Dark Bronze </div> </div>
Gasket	Silicone rubber gasket
Fasteners	PCS Polymer Coated Stainless Steel hardware
Ingress protection	IP66
Impact resistance	IK07
Corrosion resistance	5CE
Windage	0.7 ft ²

WE-EF LIGHTING USA, LLC

410-D Keystone Drive, 15086 Warrendale, PA 15086 - Phone: +1 724 742 0030
 customersupport.usa@we-ef.com - <https://we-ef.com/us>
 Subject to technical changes and errors. - Generated on 11/23/2024

111-0720

RFS530 LED

we-ef

Electrical description

Power supply	Integral [ECG] electronic driver 120V-277V. 0-10V dimmable, to be specified with order.
Driver / Ballast	Integral EC electronic converter
Power factor	< 0.9
Surge protection	In-line bracket 10kV Surge Protector

Additional information

Lifetime	Ta=25°/40° L90B10 > 90000h
BUG Rating	Please see individual Spec Sheets for classification of Backlight, Uplight and Glare.
Listings	ETL, UL-1598, CSA-C22.2#250.0. Suitable for Wet Locations.

WE-EF LIGHTING USA, LLC

410-D Keystone Drive, 15086 Warrendale, PA 15086 - Phone: +1 724 742 0030
customersupport.usa@we-ef.com - <https://we-ef.com/us>
Subject to technical changes and errors. - Generated on 11/23/2024