



Description

Profile Projector [GP] for projection of gobos on a surface. Spherical and aspherical, double flat convex lens system. Gobo motif on request, to be ordered separately.

IP66, Class I. IK05. Marine-grade, die-cast aluminium alloy. 5CE superior corrosion protection including PCS hardware. Silicone CCG® Controlled Compression Gasket. Safety glass lens. One cable gland. Second gland for through wiring on request.

Integral EC electronic converter in thermally-separated compartment. Glass LED lens array. Factory installed LED circuit board.

Custom-made gobos (outside diameter 46.6 mm, max. printable area $d = 38$ mm) available on request.

Weight	4.00 kg
Light distribution	symmetric Gobo-Projector [GP] - min aperture angle
Light source	LED-FT-26W - 4000 K
CRI	80
Power supply	EC
LEDs	1
Rated input power	28 W

Rated lumens (lm)

LED Lumen	1164.1
Total Lumen	1164.1
Ta	25

Nominal Lumen (lm)

LED Lumen	3470
Total Lumen	3470
Tc	25

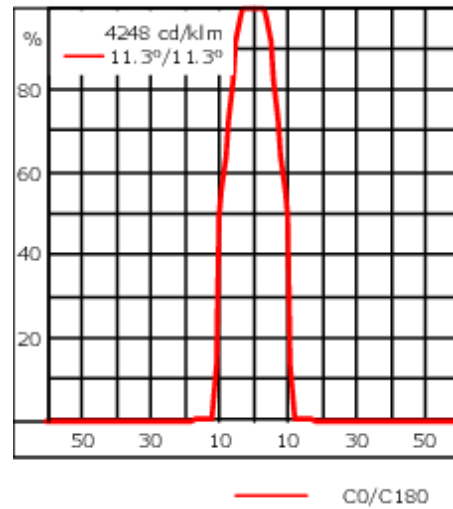

Specifications

Material description

Body	Marine-grade, die-cast aluminium alloy
Lens	Safety glass lens
Colours	<div style="display: flex; align-items: center;"> <div style="width: 20px; height: 15px; background-color: black; margin-right: 5px;"></div> RAL9004 Signal black </div> <div style="display: flex; align-items: center; margin-top: 5px;"> <div style="width: 20px; height: 15px; background-color: grey; margin-right: 5px;"></div> RAL9007 Grey aluminium </div> <div style="display: flex; align-items: center; margin-top: 5px;"> <div style="width: 20px; height: 15px; background-color: darkgrey; margin-right: 5px;"></div> RAL7016 Anthracite grey </div> <div style="display: flex; align-items: center; margin-top: 5px;"> <div style="width: 20px; height: 15px; background-color: lightgrey; margin-right: 5px;"></div> RAL9016 Traffic white </div>
Gasket	Silicone CCG® Controlled Compression Gasket
Fasteners	PCS Polymer Coated Stainless Steel Hardware
Ingress protection	IP66
Impact resistance	IK05
Corrosion resistance	5CE

Electrical description

Driver / Ballast	Integral EC electronic converter in thermally-separated compartment
Power factor	> 0.9

Additional information

WE-EF LIGHTING (Thailand) Co., Ltd.

57 Moo 5, Kingkaew Rd., Bangplee, 10540 Samutprakarn - Phone: +66 2 738 96 20 - Fax: +66 2 738 96 29

<https://we-ef.com/asia>

Subject to technical changes and errors. - Generated on 27/11/2024

Mounting Accessories

Pole clamp PC - Rotatable

Description	Part ID	D1	Weight (kg)
PC1 76-89/60 Pole clamp, single (Ø 76-89)	139-2702	76-89	1.00

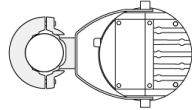

PC2 76-89/60 Pole clamp, double (Ø 76-89)	139-2703	76-89	1.00
---	----------	-------	------



FLC210 LED [GP]

Description	Part ID	D1	Weight (kg)
PC2 82-109/60 Pole clamp, double (Ø 82-109)	139-2705	82-109	1.10



PC2 102-114/60 Pole clamp, double (Ø 102-114)	139-2707	102-114	1.20
--	----------	---------	------

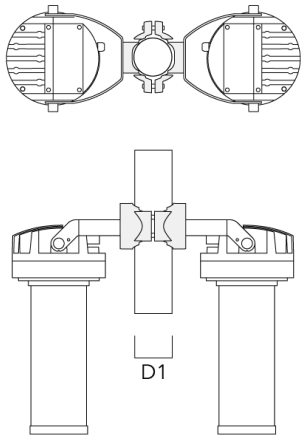

FLC210 LED [GP]

Description	Part ID	D1	Weight (kg)
PC1 114-133/60 Pole clamp, single (Ø 114-133)	139-2708	114-133	1.40



PC2 114-133/60 Pole clamp, double (Ø 114-133)	139-2709	114-133	1.40
--	----------	---------	------



139-2480_min

FLC210 LED [GP]

we-ef

Optical Accessories

Gobo cartridge

Description	Part ID
Gobo cartridge for FLC210 [GP]	139-2858

WE-EF LIGHTING (Thailand) Co., Ltd.

57 Moo 5, Kingkaew Rd., Bangplee, 10540 Samutprakarn - Phone: +66 2 738 96 20 - Fax: +66 2 738 96 29

<https://we-ef.com/asia>

Subject to technical changes and errors. - Generated on 27/11/2024