

111-0725

RFS530 LED

we-ef



Description

IP66, Class I. IK07. Marine-grade, die-cast aluminium alloy. 5CE superior corrosion protection + primer including PCS hardware. Silicone CCG® Controlled Compression Gasket. Non-reflecting safety glass lens, hinged with safety switch. Integral EC electronic converter in thermally separated compartment. CAD-optimised optics for superior illumination and glare control. OLC® One LED Concept. Factory installed LED circuit board. The luminaire is factory-sealed and does not need to be opened during installation. Optional 2200 K version available. To be specified at time of ordering.

Includes cable connector, for cable 6-12 mm. Cable inclination angle: Maximum 10°.

Weight	11.60 kg
Light distribution	asymmetric, side throw [S70]
Light source	LED-12/12W/12W / 700 mA - 3000 K
CRI	80
Power supply	EC
LEDs	12
Rated input power	27 W
Nominal Lumen (lm)	
LED Lumen	290
Total Lumen	3480
Tj	85
Rated lumens (lm)	
LED Lumen	240
Total Lumen	2879.9
Ta	25

WE-EF LIGHTING Pty Ltd

6/13 Downard Street, 3195 Braeside, Victoria - Phone: +61 3 8587 0444 - Fax: +61 3 8587 0499

info.australia@we-ef.com - <https://we-ef.com/aus>

Subject to technical changes and errors. - Generated on 23/11/2024

111-0725

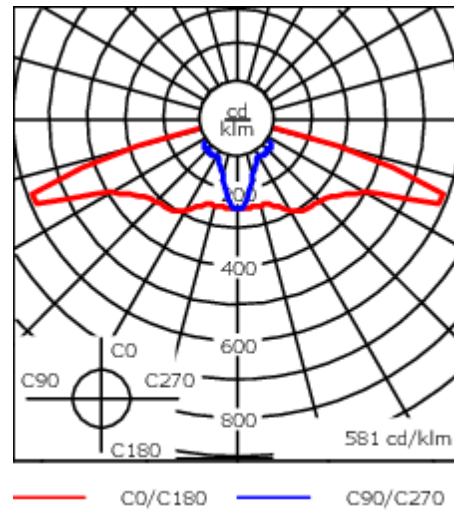
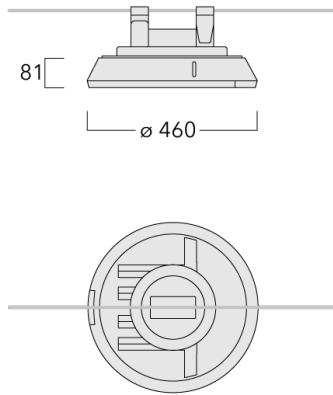

RFS530 LED

we-ef



Specifications

Material description

Body	Marine-grade, die-cast aluminium alloy
Lens	Non-reflecting safety glass lens, hinged
Colours	 RAL9004 Signal black  RAL9006 White aluminium  RAL9007 Grey aluminium
Gasket	Silicone CCG® Controlled Compression Gasket
Fasteners	PCS Polymer Coated Stainless Steel Hardware
Ingress protection	IP66
Impact resistance	IK07
Corrosion resistance	5CE+Primer
Windage	0.062 m ²

Electrical description

Power supply	220-240V / 50-60 Hz
Driver / Ballast	Integral EC electronic converter
Power factor	< 0.9

Additional information

Lifetime	Ta=40° L90B10 > 90000h
----------	------------------------

WE-EF LIGHTING Pty Ltd

6/13 Downard Street, 3195 Braeside, Victoria - Phone: +61 3 8587 0444 - Fax: +61 3 8587 0499

info.australia@we-ef.com - <https://we-ef.com/aus>

Subject to technical changes and errors. - Generated on 23/11/2024

111-0725

RFS530 LED

we-ef

Control

Eco Step Dim® Basic

Description	Part ID
Eco Step Dim® Basic LED	430-0001

Eco Step Dim® Advanced

Description	Part ID
Eco Step Dim® Advanced LED	430-0002

R2C Ready to Connect

Description	Part ID
R2C Ready to Connect (top)	430-0019

WE-EF LIGHTING Pty Ltd

6/13 Downard Street, 3195 Braeside, Victoria - Phone: +61 3 8587 0444 - Fax: +61 3 8587 0499

info.australia@we-ef.com - <https://we-ef.com/aus>

Subject to technical changes and errors. - Generated on 23/11/2024