

115-1915

CTY150 LED-FT

we-ef



Description

IP55. Class I. IK10. Marine-grade, die-cast aluminum alloy. 5CE superior corrosion protection including PCS hardware. Silicone CCG® Controlled Compression Gasket. Polycarbonate main lens. CAD-optimized indirect optics for superior illumination and glare control. Integral driver in thermally separated compartment. Factory-installed LED circuit board. 0-10V Dimming comes standard with luminaire.

Pre-wired post complete with cable connecting box and service door for mains connection.

Suitable for installation in landscaped areas or on concrete foundations.

Specify product with 7 Digit product code - Finish Color. Accessories, such as mounting, optical, and electrical, must be specified separately.

Example: XXX-XXXX-9004 (Black)
+ XXX-XXXX (Accessory 1)

Weight	25.40 lb
Light distribution	controlled symmetric distribution [C55]
Light source	LED-FT-24W (3000K)
CRI	80
Power supply	electronic gear
LEDs	1
Rated input power	27 W
Rated lumens (lm)	
LED Lumen	2925.2
Total Lumen	2925.2
Ta	25
Nominal Lumen (lm)	
LED Lumen	4220
Total Lumen	4220
Tc	25

WE-EF LIGHTING USA, LLC

410-D Keystone Drive, 15086 Warrendale, PA 15086 - Phone: +1 724 742 0030
customersupport.usa@we-ef.com - <https://we-ef.com/us>
Subject to technical changes and errors. - Generated on 11/23/2024

115-1915

CTY150 LED-FT

we-ef

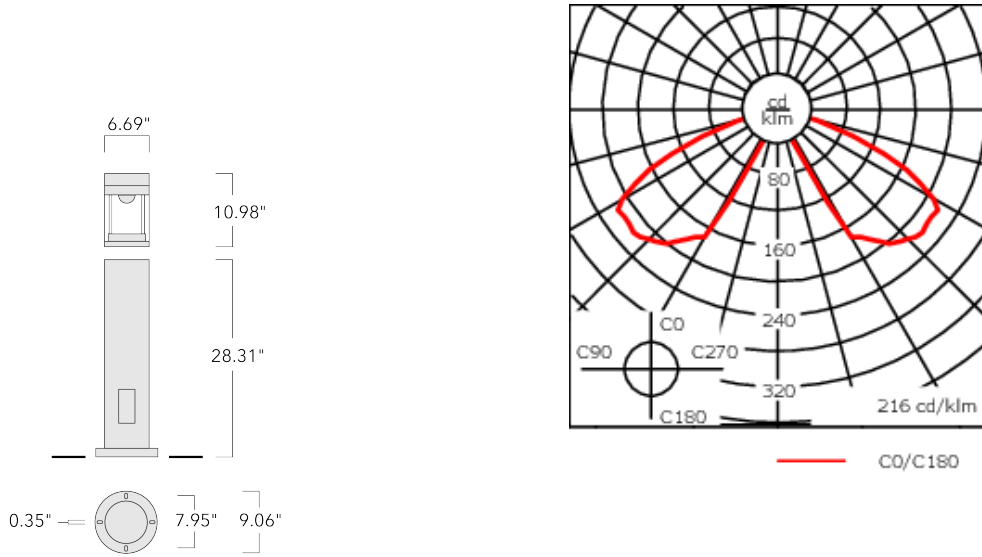

Specifications

Material description

Body	Marine-grade, die-cast aluminium alloy
Lens	Polycarbonate
Colors	<div style="display: flex; flex-direction: column; gap: 5px;"> <div> RAL9004 Black</div> <div> RAL9007 Grey Metallic</div> <div> RAL9016 White</div> <div> RAL8019 Dark Bronze</div> </div>
Gasket	Silicone CCG® Controlled Compression Gasket
Fasteners	PCS Polymer Coated Stainless Steel Hardware
Ingress protection	IP66
Impact resistance	IK10
Corrosion resistance	5CE

Electrical description

Driver / Ballast	Integral EC electronic converter
Power factor	> 0.9

Additional information

Lifetime	Ta=25°/40° L70B50 > 50000h
----------	----------------------------

WE-EF LIGHTING USA, LLC

410-D Keystone Drive, 15086 Warrendale, PA 15086 - Phone: +1 724 742 0030

customersupport.usa@we-ef.com - <https://we-ef.com/us>

Subject to technical changes and errors. - Generated on 11/23/2024

Mounting Accessories

Planted root

Description	Part ID	D1	D2	D3	D4	H1	H2	M1	M2	Weight (lb)
Planted root ESV4	300-0464	8.66	7.48	4.25	4.02	15.75	13.78	.35	.24	9.48

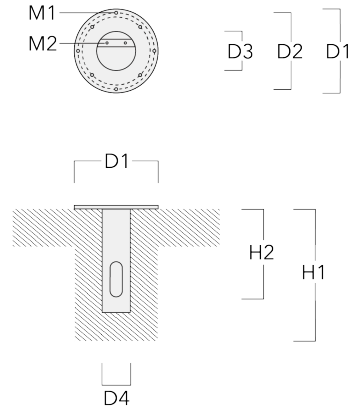

Optical Accessories

Light shield

Description	Part ID	Additional information	H1
LS180-[C60]	159-0321		120

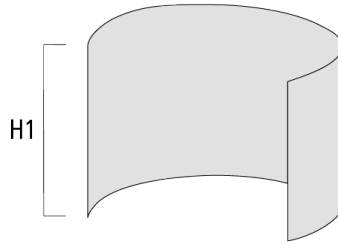

LS180	430-0029	Glare Shield for backlight spill. Glare Shield factory-installed or available as retrofit kit. Suitable for [S60], [S65], [S70], [R65], [P65] lenses. Must be specified at time of ordering.
-------	----------	--