



Description

IP66, Class I. IK10. Marine-grade, die-cast aluminium alloy. 5CE superior corrosion protection including PCS hardware. Silicone CCG® Controlled Compression Gasket. Polycarbonate main lens. Integral EC electronic converter in thermally-separated compartment. Factory installed LED circuit board. CAD-optimised optics for superior illumination and glare control. Pre-wired post complete with cable connecting box and service door for mains connection.

Optional 2200 K version available. To be specified at time of ordering.

Optional Eco Step Dim® Motion version available. To be specified at time of ordering.

Weight	25.40 lb
Light distribution	rectangular, side throw [R65]
Light source	LED-9/13W / 500 mA - 4000 K
CRI	80
Power supply	electronic gear
LEDs	9
Rated input power	15.8 W

Nominal Lumen (lm)

LED Lumen	230
Total Lumen	2070
Tj	85

Rated lumens (lm)

LED Lumen	188.1
Total Lumen	1692.8
Ta	25

WE-EF LIGHTING USA, LLC

410-D Keystone Drive, 15086 Warrendale, PA 15086 - Phone: +1 724 742 0030
customersupport.usa@we-ef.com - <https://we-ef.com/us>
Subject to technical changes and errors. - Generated on 11/23/2024

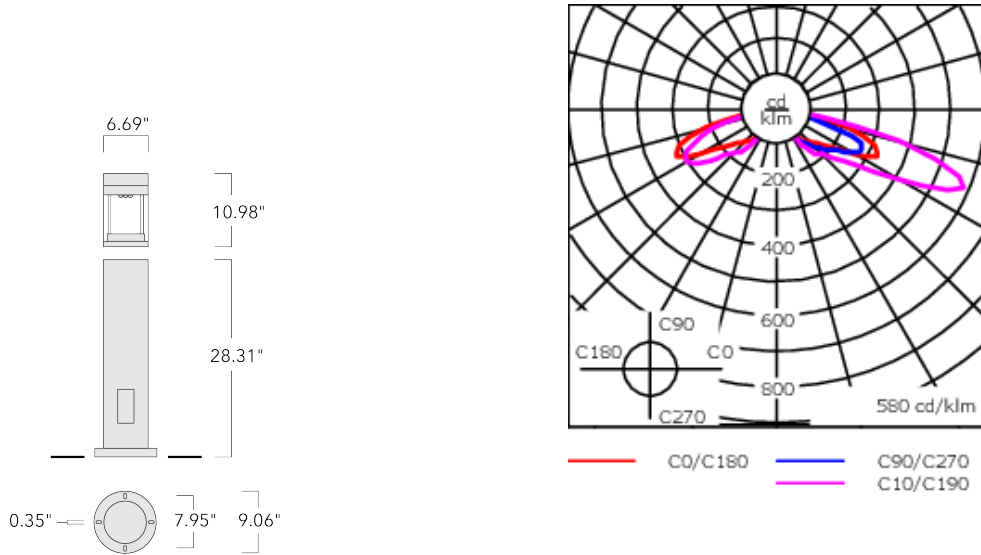

Specifications

Material description

Body	Marine-grade, all-aluminium construction
Lens	Polycarbonate
Colors	<div style="display: flex; flex-direction: column; gap: 5px;"> <div> RAL9004 Black</div> <div> RAL9007 Grey Metallic</div> <div> RAL9016 White</div> <div> RAL8019 Dark Bronze</div> </div>
Gasket	Silicone CCG® Controlled Compression Gasket
Fasteners	PCS Polymer Coated Stainless Steel Hardware
Ingress protection	IP66
Impact resistance	IK10
Corrosion resistance	5CE

Electrical description

Driver / Ballast	Integral EC electronic converter
Power factor	> 0.9

Additional information

Lifetime	Ta=25°/40° L90B10 > 90000h
----------	----------------------------

WE-EF LIGHTING USA, LLC

410-D Keystone Drive, 15086 Warrendale, PA 15086 - Phone: +1 724 742 0030
 customersupport.usa@we-ef.com - <https://we-ef.com/us>
 Subject to technical changes and errors. - Generated on 11/23/2024

Mounting Accessories

Planted root

Description	Part ID	D1	D2	D3	D4	H1	H2	M1	M2	Weight (lb)
Planted root ESV4	300-0464	8.66	7.48	4.25	4.02	15.75	13.78	.35	.24	9.48

