

115-1848

LTM440 LED-FT

we-ef



Description

IP66, Class I. IK10. Marine-grade die-cast aluminium alloy. 5CE superior corrosion protection including PCS hardware. Silicone CCG® Controlled Compression Gasket. Polycarbonate main lens. CAD-optimised optics for superior illumination and glare control.

Service door with fused cable connecting box.

Weight	25.00 kg
Light distribution	rectangular [R50]
Light source	LED-FT-24W / 700 mA - 4000 K
CRI	80
Power supply	EC
LEDs	1
Rated input power	27 W
Rated lumens (lm)	
LED Lumen	3444.5
Total Lumen	3444.5
Ta	25
Nominal Lumen (lm)	
LED Lumen	4400
Total Lumen	4400
Tc	25

WE-EF LIGHTING Pty Ltd

6/13 Downard Street, 3195 Braeside, Victoria - Phone: +61 3 8587 0444 - Fax: +61 3 8587 0499

info.australia@we-ef.com - <https://we-ef.com/aus>

Subject to technical changes and errors. - Generated on 23/11/2024

115-1848

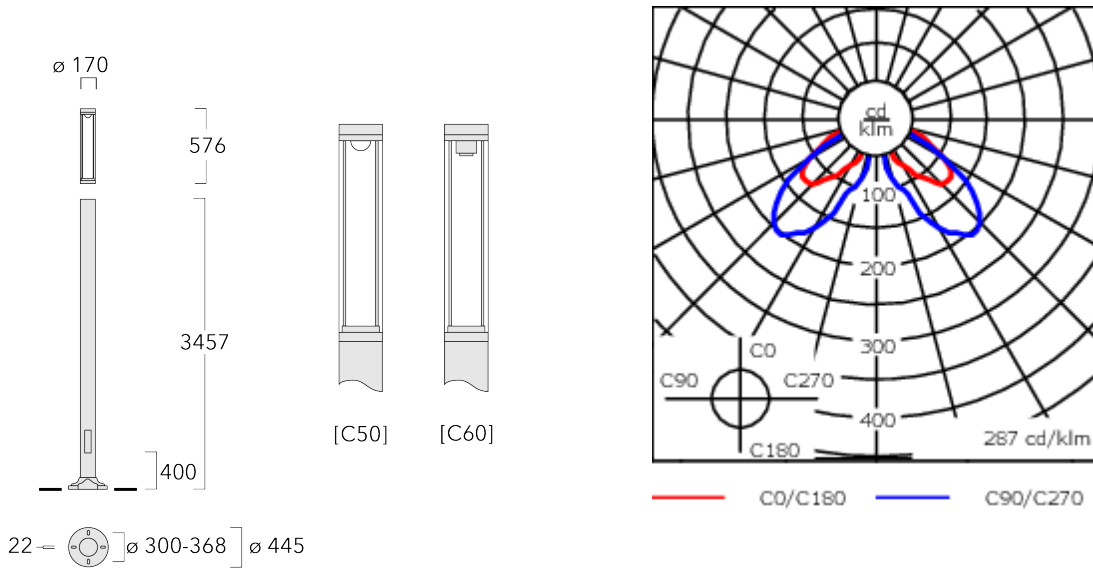

LTM440 LED-FT

we-ef



Specifications

Material description

Body	Marine-grade, all-aluminium construction
Colours	 RAL9004 Signal black  RAL9006 White aluminium  RAL9007 Grey aluminium
Gasket	Silicone CCG® Controlled Compression Gasket
Fasteners	PCS Polymer Coated Stainless Steel hardware
Ingress protection	IP66
Impact resistance	IK10
Corrosion resistance	5CE

Electrical description

Power supply	220-240V / 50-60 Hz
Driver / Ballast	Integral EC electronic converter

Additional information

Lifetime	Ta=40° L70B50 > 50000h
----------	------------------------

WE-EF LIGHTING Pty Ltd

6/13 Downard Street, 3195 Braeside, Victoria - Phone: +61 3 8587 0444 - Fax: +61 3 8587 0499

info.australia@we-ef.com - <https://we-ef.com/aus>

Subject to technical changes and errors. - Generated on 23/11/2024

115-1848

LTM440 LED-FT

we-ef

Optical Accessories

Light shield

Description	Part ID
LS180-[C60]	159-0321

WE-EF LIGHTING Pty Ltd

6/13 Downard Street, 3195 Braeside, Victoria - Phone: +61 3 8587 0444 - Fax: +61 3 8587 0499

info.australia@we-ef.com - <https://we-ef.com/aus>

Subject to technical changes and errors. - Generated on 23/11/2024