

115-1872

ZFT460-FT LED

**we-ef**



### Description

IP66, Class I. Class II on request. IK08. Marine-grade, die-cast aluminium alloy. 5CE superior corrosion protection including PCS hardware. Silicone CCG® Controlled Compression Gasket. PMMA main lens. The luminaire is factory sealed and does not need to be opened during installation. Integral EC converter. Factory installed LED circuit board. Removable LED boards for upgrading. CAD-optimised indirect optics for superior illumination and glare control.

Weight	7.10 kg
Light distribution	rectangular [R50]
Light source	LED-FT-37W / 700 mA - 4000 K
CRI	80
Power supply	EC
LEDs	1
Rated input power	42 W
<b>Rated lumens (lm)</b>	
LED Lumen	5094.1
Total Lumen	5094.1
Ta	25
<b>Nominal Lumen (lm)</b>	
LED Lumen	6695
Total Lumen	6695
Tc	25

### Fagerhult Lighting Ltd

33-34 Dolben Street, SE1 0UQ London, United Kingdom

<https://we-ef.com/uk>

Subject to technical changes and errors. - Generated on 24/11/2024

115-1872



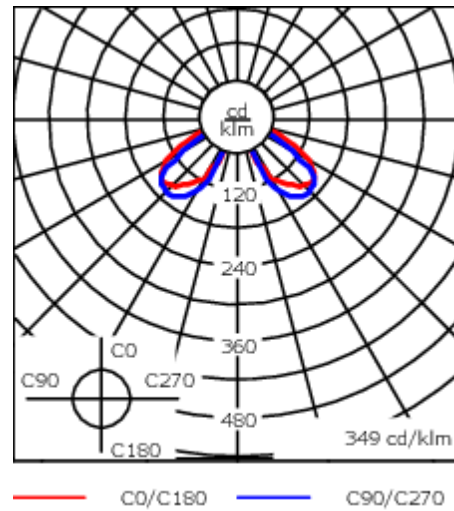
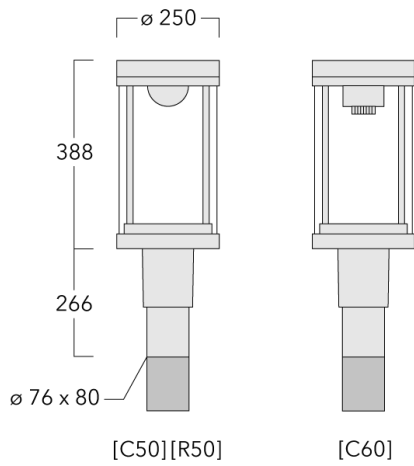

ZFT460-FT LED

**we-ef**



## Specifications

### Material description

Body	Marine-grade, die-cast aluminium alloy
Lens	PMMA
Colours	 RAL9004 Signal black  RAL9006 White aluminium  RAL9007 Grey aluminium  RAL7016 Anthracite grey  RAL9016 Traffic white
Gasket	Silicone CCG® Controlled Compression Gasket
Fasteners	PCS Polymer Coated Stainless Steel Hardware
Ingress protection	IP66
Impact resistance	IK08
Corrosion resistance	5CE
Windage	0.162 m <sup>2</sup>

### Electrical description

Power supply	220-240V / 50-60 Hz
Driver / Ballast	Integral EC electronic converter
Power factor	> 0.9
Surge protection	6/6 kV (optional SP10)

#### Fagerhult Lighting Ltd

33-34 Dolben Street, SE1 0UQ London, United Kingdom

<https://we-ef.com/uk>

Subject to technical changes and errors. - Generated on 24/11/2024

**115-1872**

**ZFT460-FT LED**

**we-ef**

**Additional information**

---

Lifetime Ta=25° L70B50 > 50000h

Energy efficiency class C-D (Light source)

---

**115-1872**

**ZFT460-FT LED**

**we-ef**

## **Control**

### **Eco Step Dim® Basic**

Description	Part ID
Eco Step Dim® Basic LED	430-0001

### **Eco Step Dim® Advanced**

Description	Part ID
Eco Step Dim® Advanced LED	430-0002

**Fagerhult Lighting Ltd**

33-34 Dolben Street, SE1 0UQ London, United Kingdom

<https://we-ef.com/uk>

Subject to technical changes and errors. - Generated on 24/11/2024

**Mounting Accessories**

**Wall and pole brackets RZ**

Description	Part ID	C1	D1	D2	D × L1	M1	Weight (kg)
RZ0-400 Wall bracket, single	115-1324	277	231	195	76 x 80	12	3.50



RZ2-400 Pole bracket, double	115-1323	258			76 x 100		4.90
------------------------------	----------	-----	--	--	----------	--	------



115-1872

ZFT460-FT LED

**we-ef**

## Optical Accessories

### Light shield

---

Description	Part ID	H1
LS180-[C60]	159-0321	120

---

