

145-7181

FLC301 Spigot mounted

**we-ef**



#### Description

IP66. IK07. Marine-grade, die-cast aluminium alloy. 5CE superior corrosion protection + primer including PCS hardware. Safety glass lens. Silicone CCG® Controlled Compression Gasket. Luminaire is factory-sealed and does not need to be opened during installation.

Advanced thermal management protects LEDs while optimising lumens output. CAD-optimised optics for superior illumination and glare control. Including 1.5 m of flexible PVC free cable.

Mains voltage versions, ON-OFF Class I. Integral EC electronic converter.

24VDC low voltage versions, ON-OFF Class III. DALI Class I.

Remote 24VDC power supply to be ordered separately.

Weight	0.70 kg
Light distribution	symmetric, wide beam [B]
Light source	LED-1/4W / 350 mA - 3000 K
CRI	80
Power supply	EC
LEDs	1
Rated input power	5 W
<b>Nominal Lumen (lm)</b>	
LED Lumen	490
Total Lumen	490
Tj	85
<b>Rated lumens (lm)</b>	
LED Lumen	379.1
Total Lumen	379.1
Ta	25

#### WE-EF LIGHTING Pty Ltd

6/13 Downard Street, 3195 Braeside, Victoria - Phone: +61 3 8587 0444 - Fax: +61 3 8587 0499

info.australia@we-ef.com - <https://we-ef.com/aus>

Subject to technical changes and errors. - Generated on 23/10/2024

145-7181

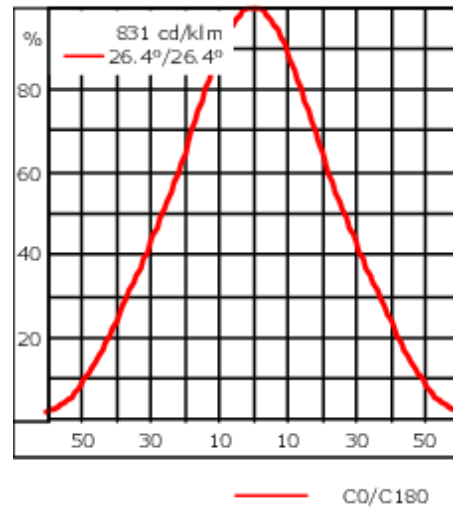
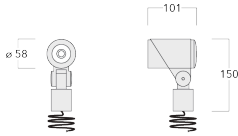

FLC301 Spigot mounted

**we-ef**



## Specifications

### Material description

Body	Marine-grade, die-cast aluminium alloy
Lens	Safety glass lens
Colours	 RAL9004 Signal black  RAL9006 White aluminium  RAL9007 Grey aluminium
Gasket	Silicone CCG® Controlled Compression Gasket
Fasteners	PCS Polymer Coated Stainless Steel Hardware (unpainted)
Ingress protection	IP66
Impact resistance	IK07
Corrosion resistance	5CE+Primer
Windage	0.015 m <sup>2</sup>

### Electrical description

Driver / Ballast	Integral EC electronic converter
Power factor	>0.9

### Additional information

Lifetime	Ta=40° L90B10 > 90000h
----------	------------------------

#### WE-EF LIGHTING Pty Ltd

6/13 Downard Street, 3195 Braeside, Victoria - Phone: +61 3 8587 0444 - Fax: +61 3 8587 0499

info.australia@we-ef.com - <https://we-ef.com/aus>

Subject to technical changes and errors. - Generated on 23/10/2024

**FLC301 Spigot mounted**

**Mounting Accessories**

**Flat surface and Column fitter**

Description	Part ID	A	B	Weight (kg)
Column fitter FLC300	145-9536	70		0.20

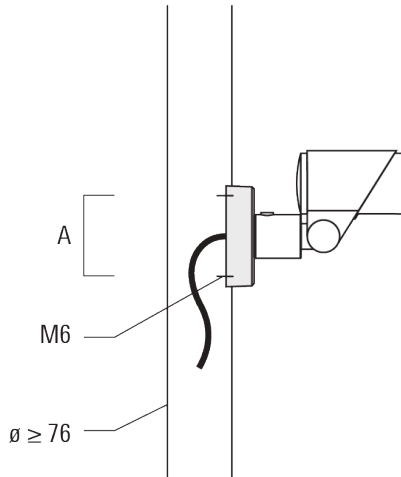

Flat surface fitter FLC300	145-9535	100	85	0.20
----------------------------	----------	-----	----	------

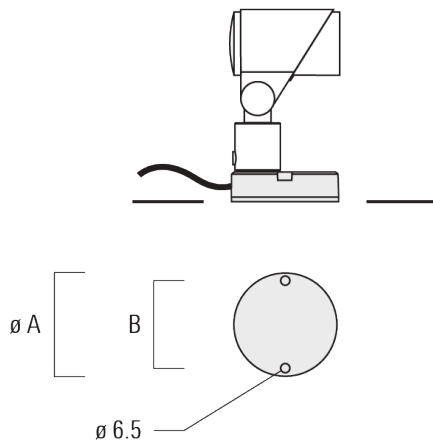

**Ground spike EF**

**WE-EF LIGHTING Pty Ltd**

6/13 Downard Street, 3195 Braeside, Victoria - Phone: +61 3 8587 0444 - Fax: +61 3 8587 0499

info.australia@we-ef.com - <https://we-ef.com/aus>

Subject to technical changes and errors. - Generated on 23/10/2024

**FLC301 Spigot mounted**

Description	Part ID	A	Weight (kg)
Ground spike EF1 for FLC300	310-9102	270	1.20

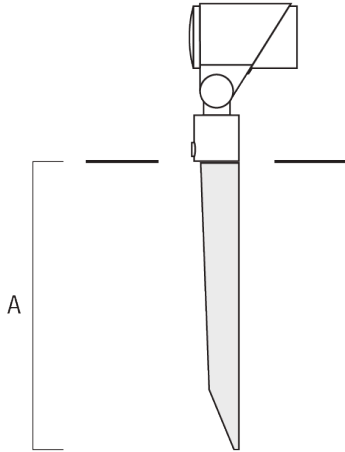

**Junction box JB1**

Description	Part ID	A	B	C1	D1	Weight (kg)
Junction box JB1 with side entry	310-9002	107	67	135	67	1.20

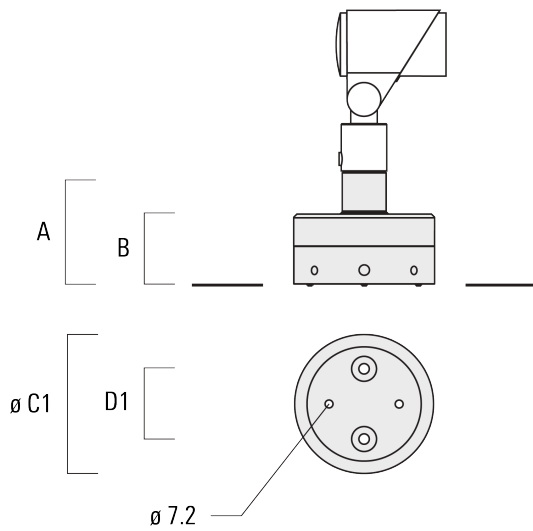

**FLC301 Spigot mounted**

Description	Part ID	A	B	C1	D1	Weight (kg)
Junction box JB1 with wall entry	310-9025	107	67	135	67	1.10

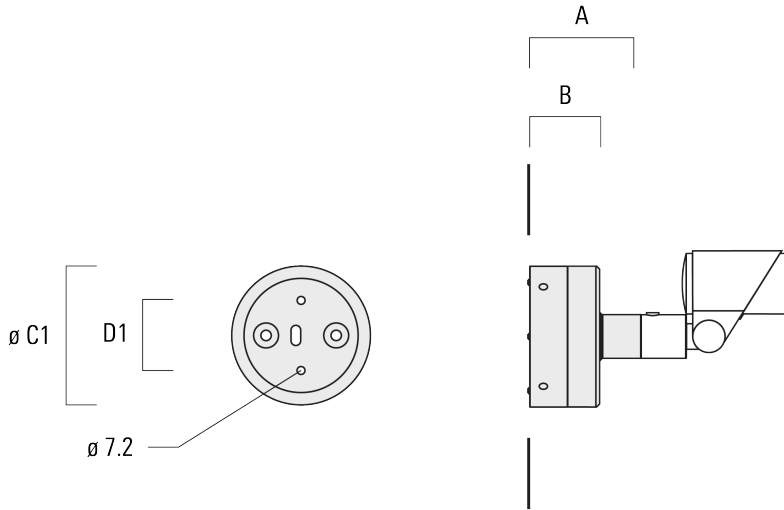

145-7181

FLC301 Spigot mounted

**we-ef**

## Optical Accessories

### Linear spread lens

Description	Part ID	C1
Linear spread lens IO-180	145-7229	42.5

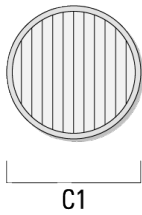

### Wallwash lens

Description	Part ID	C1
Wallwash lens IO-20	145-7230	42.5

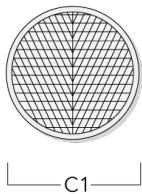

### Honeycomb louvre

#### WE-EF LIGHTING Pty Ltd

6/13 Downard Street, 3195 Braeside, Victoria - Phone: +61 3 8587 0444 - Fax: +61 3 8587 0499

info.australia@we-ef.com - <https://we-ef.com/aus>

Subject to technical changes and errors. - Generated on 23/10/2024

145-7181

**we-ef**

**FLC301 Spigot mounted**

---

Description	Part ID	C1
Honeycomb louvre IW	145-7231	42.5

---

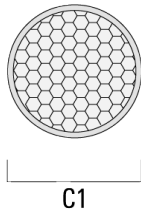

---

**Glare shield**

---

Description	Part ID	A	C1
Glare shield ES	145-7232	20.5	58

---

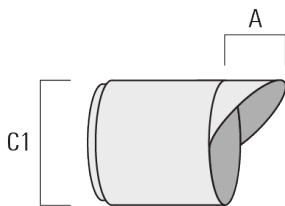

---

**Snoot**

**WE-EF LIGHTING Pty Ltd**

6/13 Downard Street, 3195 Braeside, Victoria - Phone: +61 3 8587 0444 - Fax: +61 3 8587 0499

info.australia@we-ef.com - <https://we-ef.com/aus>

Subject to technical changes and errors. - Generated on 23/10/2024

145-7181

**we-ef**

**FLC301 Spigot mounted**

---

Description	Part ID	A	C1
Snoot ET	145-7233	22.5	58

---

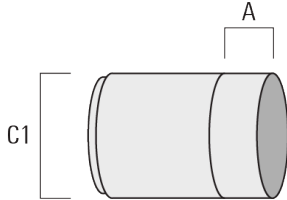



**145-7181**

**FLC301 Spigot mounted**

**we-ef**

## **Control**

### **DALI interface**

Description	Part ID
Low voltage DALI interface	0026

### **Electronic converter**

Description	Part ID
24VDC low voltage version	0025

**WE-EF LIGHTING Pty Ltd**

6/13 Downard Street, 3195 Braeside, Victoria - Phone: +61 3 8587 0444 - Fax: +61 3 8587 0499

info.australia@we-ef.com - <https://we-ef.com/aus>

Subject to technical changes and errors. - Generated on 23/10/2024

**145-7181**

**FLC301 Spigot mounted**

**WE-EF LIGHTING Pty Ltd**

6/13 Downard Street, 3195 Braeside, Victoria

Phone: +61 3 8587 0444

Fax: +61 3 8587 0499

info.australia@we-ef.com

<https://we-ef.com/aus>

Subject to technical changes and errors.

Generated on 23/10/2024