

145-7181

FLC301 Spigot mounted

we-ef



Description

IP66. IK07. Marine-grade, die-cast aluminium alloy. 5CE superior corrosion protection including PCS hardware. Safety glass lens. Silicone CCG® Controlled Compression Gasket. Luminaire is factory-sealed and does not need to be opened during installation.

Advanced thermal management protects LEDs while optimising lumens output. CAD-optimised optics for superior illumination and glare control. Including 1.5 m of flexible PVC free cable.

Mains voltage versions, ON-OFF Class I. Integral EC electronic converter.

24VDC low voltage versions, ON-OFF or DALI Class II can be ordered remote gear box 145-7234.

24VDC low voltage versions, ON-OFF Class III. DALI (only 4W available) Class I.

Remote 24VDC power supply to be ordered separately.

Optical accessories are factory-installed. To be specified at time of ordering.

Weight	0.70 kg
Light distribution	symmetric, wide beam [B]
Light source	LED-1/4W / 350 mA - 3000 K
CRI	80
Power supply	EC
LEDs	1
Rated input power	5 W

Nominal Lumen (lm)

LED Lumen	490
Total Lumen	490
Tj	85

Rated lumens (lm)

LED Lumen	379.1
Total Lumen	379.1
Ta	25

WE-EF LIGHTING (Thailand) Co., Ltd.

57 Moo 5, Kingkaew Rd., Bangplee, 10540 Samutprakarn - Phone: +66 2 738 96 20 - Fax: +66 2 738 96 29

<https://we-ef.com/asia>

Subject to technical changes and errors. - Generated on 23/10/2024

145-7181



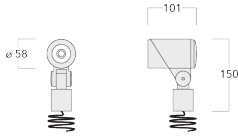

FLC301 Spigot mounted

we-ef



Specifications

Material description

Body	Marine-grade, die-cast aluminium alloy
Lens	Safety glass lens
Colours	 RAL9004 Signal black  RAL9007 Grey aluminium  RAL7016 Anthracite grey  RAL9016 Traffic white
Gasket	Silicone CCG® Controlled Compression Gasket
Fasteners	PCS hardware
Ingress protection	IP66
Impact resistance	IK07
Corrosion resistance	5CE
Windage	0.015 m ²

Electrical description

Driver / Ballast	Integral EC electronic converter (mains voltage). Integral ED electronic driver (24VDC low voltage).
Power factor	>0.9

Additional information

Lifetime	T _a =25° L90B10 > 90000h
----------	-------------------------------------

WE-EF LIGHTING (Thailand) Co., Ltd.

57 Moo 5, Kingkaew Rd., Bangplee, 10540 Samutprakarn - Phone: +66 2 738 96 20 - Fax: +66 2 738 96 29

<https://we-ef.com/asia>

Subject to technical changes and errors. - Generated on 23/10/2024

145-7181

FLC301 Spigot mounted

we-ef

Electrical Accessories

Gear box

Description	Part ID	Additional information	A	B	C1	Weight (kg)
Gear box CGB320	145-7234	Remote gear box for CLASS II	39	82	142	0.40

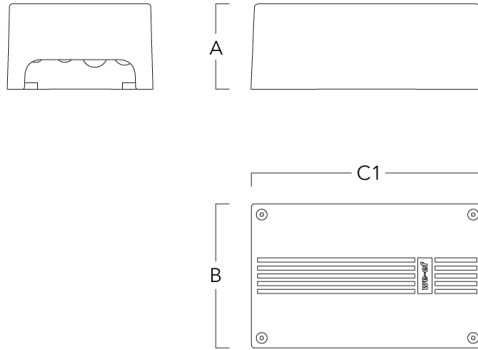

FLC301 Spigot mounted

Mounting Accessories

Flat surface and Column fitter

Description	Part ID	A	B	Weight (kg)
Column fitter FLC300	145-9536	70		0.20



Flat surface fitter FLC300	145-9535	100	85	0.20
----------------------------	----------	-----	----	------



Ground spike

FLC301 Spigot mounted

Description	Part ID	A	Weight (kg)
Ground spike EF1 for FLC300	310-9102	270	1.20

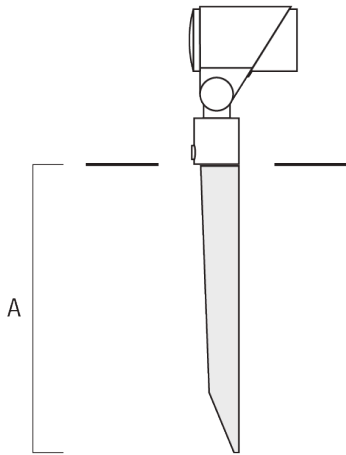

Junction box

Description	Part ID	A	B	C1	D1	Weight (kg)
Junction box JB1 with side entry	310-9002	107	67	135	67	1.20

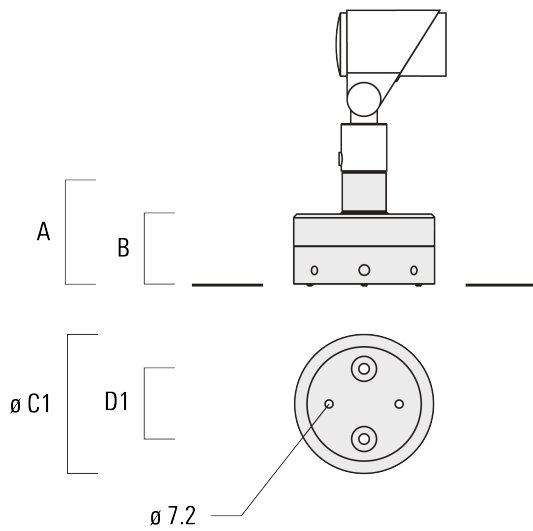

FLC301 Spigot mounted

Description	Part ID	A	B	C1	D1	Weight (kg)
Junction box JB1 with wall entry	310-9025	107	67	135	67	1.10



145-7181

FLC301 Spigot mounted

we-ef

Optical Accessories

Linear spread lens

Description	Part ID	C1
Linear spread lens IO-180	145-7229	42.5



Wallwash lens

Description	Part ID	C1
Wallwash lens IO-20	145-7230	42.5



Honeycomb louvre

WE-EF LIGHTING (Thailand) Co., Ltd.

57 Moo 5, Kingkaew Rd., Bangplee, 10540 Samutprakarn - Phone: +66 2 738 96 20 - Fax: +66 2 738 96 29

<https://we-ef.com/asia>

Subject to technical changes and errors. - Generated on 23/10/2024

145-7181

we-ef

FLC301 Spigot mounted

Description	Part ID	C1
Honeycomb louvre IW	145-7231	42.5

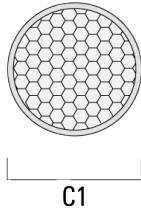

Glare shield

Description	Part ID	A	C1
Glare shield ES	145-7232	20.5	58

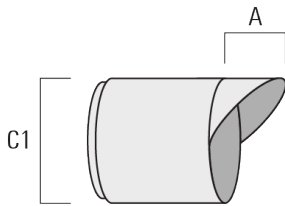

Snoot

WE-EF LIGHTING (Thailand) Co., Ltd.

57 Moo 5, Kingkaew Rd., Bangplee, 10540 Samutprakarn - Phone: +66 2 738 96 20 - Fax: +66 2 738 96 29

<https://we-ef.com/asia>

Subject to technical changes and errors. - Generated on 23/10/2024

145-7181

we-ef

FLC301 Spigot mounted

Description	Part ID	A	C1
Snoot ET	145-7233	22.5	58

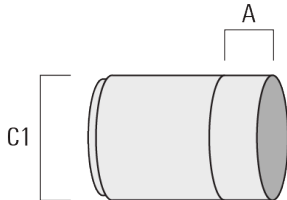

145-7181

FLC301 Spigot mounted

we-ef

Control

DALI interface

Description	Part ID
Low voltage DALI interface	0026

WE-EF LIGHTING (Thailand) Co., Ltd.

57 Moo 5, Kingkaew Rd., Bangplee, 10540 Samutprakarn - Phone: +66 2 738 96 20 - Fax: +66 2 738 96 29

<https://we-ef.com/asia>

Subject to technical changes and errors. - Generated on 23/10/2024

145-7181

FLC301 Spigot mounted

WE-EF LIGHTING (Thailand) Co., Ltd.

57 Moo 5, Kingkaew Rd., Bangplee, 10540 Samutprakarn

Phone: +66 2 738 96 20

Fax: +66 2 738 96 29

<https://we-ef.com/asia>

Subject to technical changes and errors.

Generated on 23/10/2024