



### Description

IP66. IK07. Marine-grade, die-cast aluminium alloy. 5CE superior corrosion protection including PCS hardware. Safety glass lens. Silicone CCG® Controlled Compression Gasket. Luminaire is factory-sealed and does not need to be opened during installation. Knuckle permits 340° rotation, forward tilt 73° and backward tilt 90°.

Advanced thermal management protects LEDs while optimising lumens output. CAD-optimised optics for superior illumination and glare control. Including 1.5 m of flexible PVC free cable.

Mains voltage versions, ON-OFF Class I. Integral EC electronic converter.

Optical accessories are factory-installed. To be specified at time of ordering.

Weight	0.70 kg
Light distribution	symmetric, medium beam [M]
Light source	LED-1/4W / 350 mA - 2700 K
CRI	80
Power supply	EC
LEDs	1
Rated input power	5 W
<b>Nominal Lumen (lm)</b>	
LED Lumen	490
Total Lumen	490
Tj	85
<b>Rated lumens (lm)</b>	
LED Lumen	398.4
Total Lumen	398.4
Ta	25

145-7183



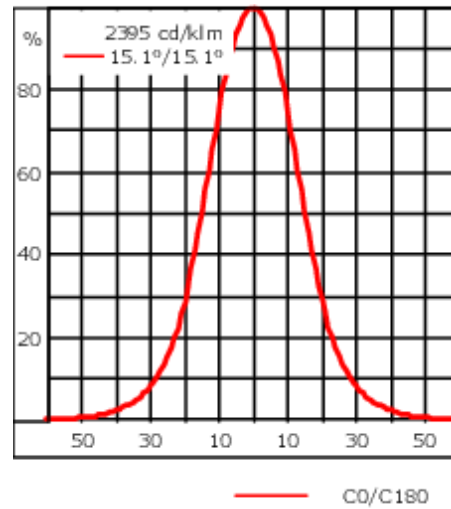
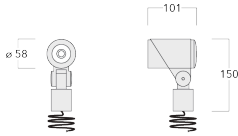

FLC301 Spigot mounted

we-ef



## Specifications

### Material description

Body	Marine-grade, die-cast aluminium alloy
Lens	Safety glass lens
Colours	 RAL9004 Signal black  RAL9006 White aluminium  RAL9007 Grey aluminium  RAL7016 Anthracite grey  RAL9016 Traffic white
Gasket	Silicone CCG® Controlled Compression Gasket
Fasteners	PCS hardware
Ingress protection	IP66
Impact resistance	IK07
Corrosion resistance	5CE
Windage	0.015 m <sup>2</sup>

### Electrical description

Driver / Ballast	Integral EC electronic converter
Power factor	>0.9

### Additional information

Lifetime	Ta=25° L90B10 > 90000h
Energy efficiency class	D-E (Light source)

Fagerhult Lighting Ltd

33-34 Dolben Street, SE1 0UQ London, United Kingdom

<https://we-ef.com/uk>

Subject to technical changes and errors. - Generated on 23/11/2024

**FLC301 Spigot mounted**

**Mounting Accessories**

**Flat surface and Column fitter**

Description	Part ID	A	B	Weight (kg)
Column fitter FLC300	145-9536	70		0.20

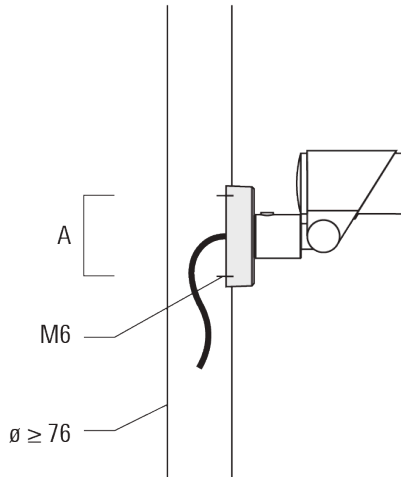

Flat surface fitter FLC300	145-9535	100	85	0.20
----------------------------	----------	-----	----	------

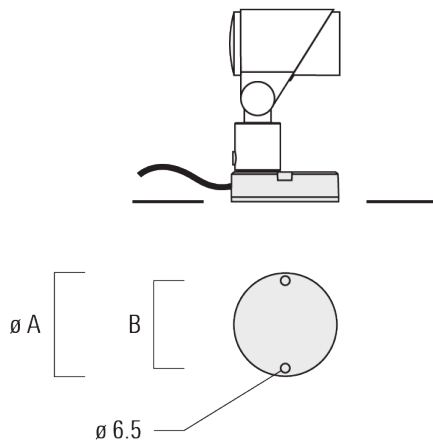

**FLC301 Spigot mounted**

**Ground spike EF**

Description	Part ID	A	Weight (kg)
Ground spike EF1 for FLC300	310-9102	270	1.20

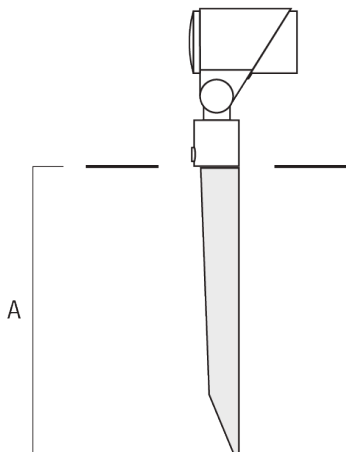

**Junction box JB1**

Description	Part ID	A	B	C1	D1	Weight (kg)
Junction box JB1 with side entry	310-9002	107	67	135	67	1.20

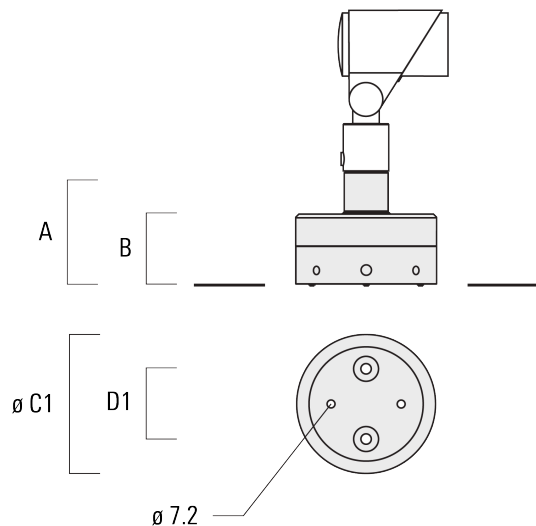

**FLC301 Spigot mounted**

Description	Part ID	A	B	C1	D1	Weight (kg)
Junction box JB1 with wall entry	310-9025	107	67	135	67	1.10

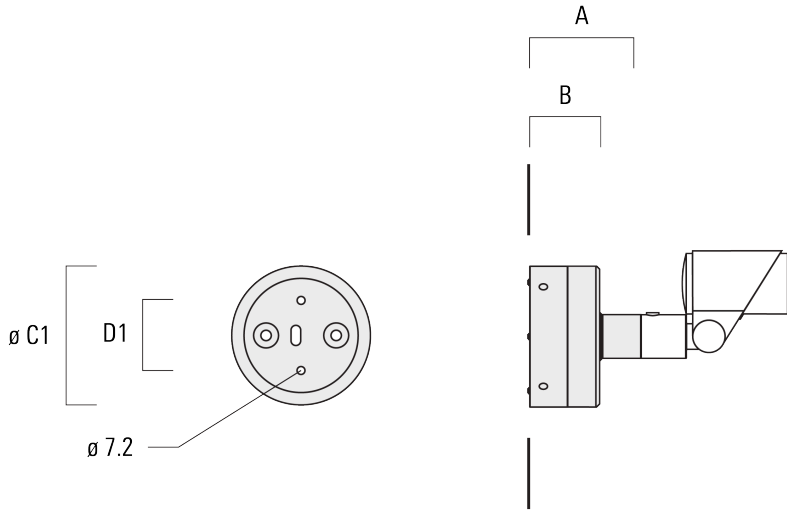

145-7183

FLC301 Spigot mounted

**we-ef**

## Optical Accessories

### Linear spread lens

Description	Part ID	C1
Linear spread lens IO-180	145-7229	42.5

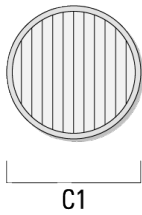

### Wallwash lens

Description	Part ID	C1
IO-20-WW-FLC301-LED	145-7230	42.5

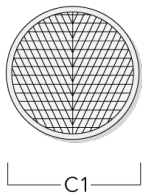

#### Fagerhult Lighting Ltd

33-34 Dolben Street, SE1 0UQ London, United Kingdom

<https://we-ef.com/uk>

Subject to technical changes and errors. - Generated on 23/11/2024

**FLC301 Spigot mounted**

**Honeycomb louvre**

---

Description	Part ID	C1
Honeycomb louvre IW	145-7231	42.5

---

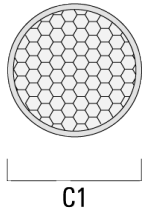

---

**Glare shield**

---

Description	Part ID	A	C1
Glare shield ES	145-7232	20.5	58

---

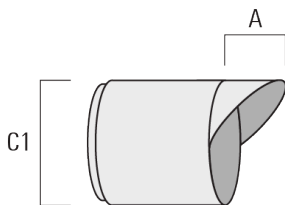

145-7183

**we-ef**

**FLC301 Spigot mounted**

**Snoot**

---

Description	Part ID	A	C1
Snoot ET	145-7233	22.5	58

---

