

145-7191

FLC301 Spigot mounted

**we-ef**



### Description

IP66. IK07. Marine-grade, die-cast aluminium alloy. 5CE superior corrosion protection including PCS hardware. Safety glass lens. Silicone CCG® Controlled Compression Gasket. Luminaire is factory-sealed and does not need to be opened during installation.

Advanced thermal management protects LEDs while optimising lumens output. CAD-optimised optics for superior illumination and glare control. Including 1.5 m of flexible PVC free cable.

Mains voltage versions, ON-OFF Class I. Integral EC electronic converter.

24VDC low voltage versions, ON-OFF or DALI Class II can be ordered remote gear box 145-7234.

24VDC low voltage versions, ON-OFF Class III. DALI (only 4W available) Class I.

Remote 24VDC power supply to be ordered separately.

Optical accessories are factory-installed. To be specified at time of ordering.

Weight	0.70 kg
Light distribution	symmetric, very narrow beam, sharp cut-off [EES]
Light source	LED-1/4W / 350 mA - 4000 K
CRI	80
Power supply	EC
LEDs	1
Rated input power	5 W

### Nominal Lumen (lm)

LED Lumen	490
Total Lumen	490
Tj	85

### Rated lumens (lm)

LED Lumen	411.6
Total Lumen	411.6
Ta	25

**WE-EF LIGHTING (Thailand) Co., Ltd.**

57 Moo 5, Kingkaew Rd., Bangplee, 10540 Samutprakarn - Phone: +66 2 738 96 20 - Fax: +66 2 738 96 29

<https://we-ef.com/asia>

Subject to technical changes and errors. - Generated on 23/10/2024

145-7191



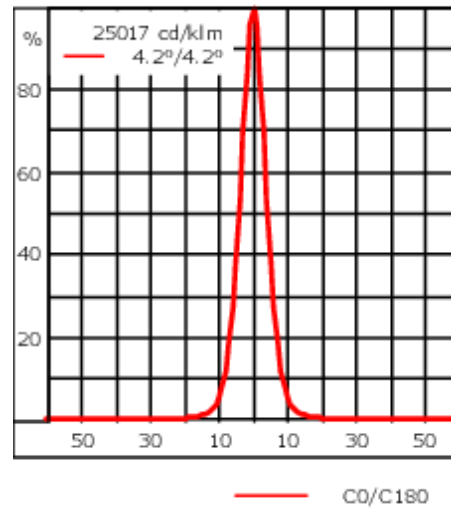

FLC301 Spigot mounted

**we-ef**



## Specifications

### Material description

Body	Marine-grade, die-cast aluminium alloy
Lens	Safety glass lens
Colours	 RAL9004 Signal black  RAL9007 Grey aluminium  RAL7016 Anthracite grey  RAL9016 Traffic white
Gasket	Silicone CCG® Controlled Compression Gasket
Fasteners	PCS hardware
Ingress protection	IP66
Impact resistance	IK07
Corrosion resistance	5CE
Windage	0.015 m <sup>2</sup>

### Electrical description

Driver / Ballast	Integral EC electronic converter (mains voltage). Integral ED electronic driver (24VDC low voltage).
Power factor	>0.9

### Additional information

Lifetime	T <sub>a</sub> =25° L90B10 > 90000h
----------	-------------------------------------

**WE-EF LIGHTING (Thailand) Co., Ltd.**

57 Moo 5, Kingkaew Rd., Bangplee, 10540 Samutprakarn - Phone: +66 2 738 96 20 - Fax: +66 2 738 96 29

<https://we-ef.com/asia>

Subject to technical changes and errors. - Generated on 23/10/2024

145-7191

FLC301 Spigot mounted

**we-ef**

## Electrical Accessories

### Gear box

Description	Part ID	Additional information	A	B	C1	Weight (kg)
Gear box CGB320	145-7234	Remote gear box for CLASS II	39	82	142	0.40

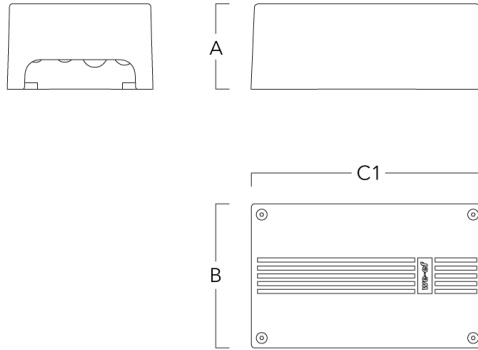

**FLC301 Spigot mounted**

**Mounting Accessories**

**Flat surface and Column fitter**

Description	Part ID	A	B	Weight (kg)
Column fitter FLC300	145-9536	70		0.20



Flat surface fitter FLC300	145-9535	100	85	0.20
----------------------------	----------	-----	----	------



**Ground spike**

**FLC301 Spigot mounted**

Description	Part ID	A	Weight (kg)
Ground spike EF1 for FLC300	310-9102	270	1.20

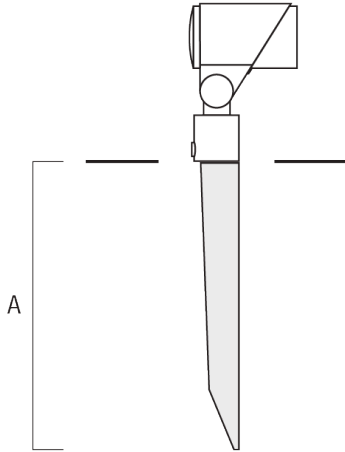

**Junction box**

Description	Part ID	A	B	C1	D1	Weight (kg)
Junction box JB1 with side entry	310-9002	107	67	135	67	1.20

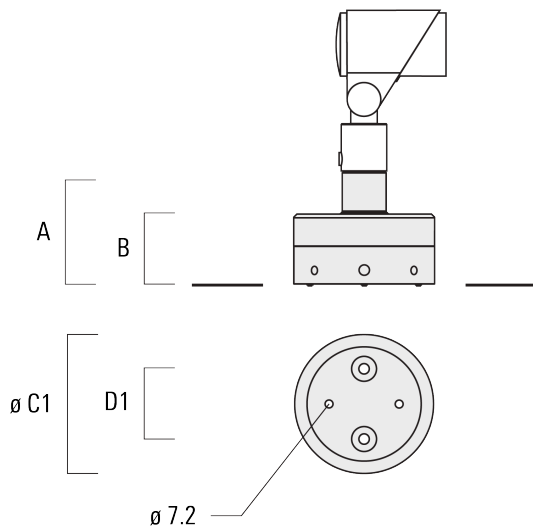

**FLC301 Spigot mounted**

Description	Part ID	A	B	C1	D1	Weight (kg)
Junction box JB1 with wall entry	310-9025	107	67	135	67	1.10



145-7191

FLC301 Spigot mounted

**we-ef**

## Optical Accessories

### Linear spread lens

Description	Part ID	C1
Linear spread lens IO-180	145-7229	42.5

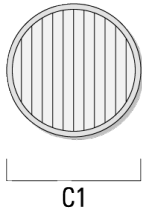

### Wallwash lens

Description	Part ID	C1
Wallwash lens IO-20	145-7230	42.5



### Honeycomb louvre

**WE-EF LIGHTING (Thailand) Co., Ltd.**

57 Moo 5, Kingkaew Rd., Bangplee, 10540 Samutprakarn - Phone: +66 2 738 96 20 - Fax: +66 2 738 96 29

<https://we-ef.com/asia>

Subject to technical changes and errors. - Generated on 23/10/2024

**FLC301 Spigot mounted**

Description	Part ID	C1
Honeycomb louvre IW	145-7231	42.5

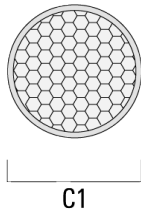

**Glare shield**

Description	Part ID	A	C1
Glare shield ES	145-7232	20.5	58

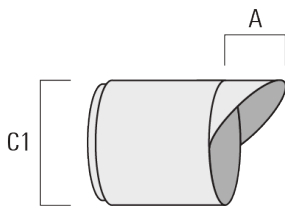

**Snoot**



145-7191

**we-ef**

**FLC301 Spigot mounted**

---

Description	Part ID	A	C1
Snoot ET	145-7233	22.5	58

---

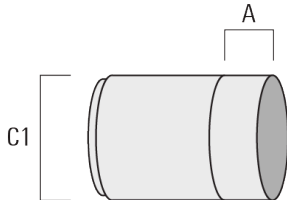

---

**WE-EF LIGHTING (Thailand) Co., Ltd.**

57 Moo 5, Kingkaew Rd., Bangplee, 10540 Samutprakarn - Phone: +66 2 738 96 20 - Fax: +66 2 738 96 29

<https://we-ef.com/asia>

Subject to technical changes and errors. - Generated on 23/10/2024

**145-7191**

**FLC301 Spigot mounted**

**we-ef**

## **Control**

### **DALI interface**

Description	Part ID
Low voltage DALI interface	0026

**WE-EF LIGHTING (Thailand) Co., Ltd.**

57 Moo 5, Kingkaew Rd., Bangplee, 10540 Samutprakarn - Phone: +66 2 738 96 20 - Fax: +66 2 738 96 29

<https://we-ef.com/asia>

Subject to technical changes and errors. - Generated on 23/10/2024

**145-7191**

**FLC301 Spigot mounted**

**WE-EF LIGHTING (Thailand) Co., Ltd.**

57 Moo 5, Kingkaew Rd., Bangplee, 10540 Samutprakarn

Phone: +66 2 738 96 20

Fax: +66 2 738 96 29

<https://we-ef.com/asia>

Subject to technical changes and errors.

Generated on 23/10/2024