

145-7196

**we-ef**

**FLC301 Surface mounted**



**Description**

IP66. IK07. Marine-grade, die-cast aluminium alloy. 5CE superior corrosion protection including PCS hardware. Safety glass lens. Silicone CCG® Controlled Compression Gasket. Luminaire is factory-sealed and does not need to be opened during installation.

Advanced thermal management protects LEDs while optimising lumens output. CAD-optimised optics for superior illumination and glare control.

Optical accessories are factory-installed. To be specified at time of ordering.

4W / 120V mains voltage version, ON-OFF Class I. Non-dimming.

6W / 24V DC low voltage version available upon request, ON-OFF Class III. Non-dimming.

Dimmable version can only be done with a remote driver (120-277V)

347V remote driver on request.

Weight	0.80 lb
Light distribution	symmetric, medium beam [M]
Light source	LED-1/4W / 350 mA - 3000 K
CRI	80
Power supply	electronic gear
LEDs	1
Rated input power	5 W

**Nominal Lumen (lm)**

LED Lumen	490
Total Lumen	490
Tj	85

**Rated lumens (lm)**

LED Lumen	398.4
Total Lumen	398.4
Ta	25

**WE-EF LIGHTING USA, LLC**

410-D Keystone Drive, 15086 Warrendale, PA 15086 - Phone: +1 724 742 0030

customersupport.usa@we-ef.com - <https://we-ef.com/us>

Subject to technical changes and errors. - Generated on 10/23/2024

145-7196

we-ef

FLC301 Surface mounted

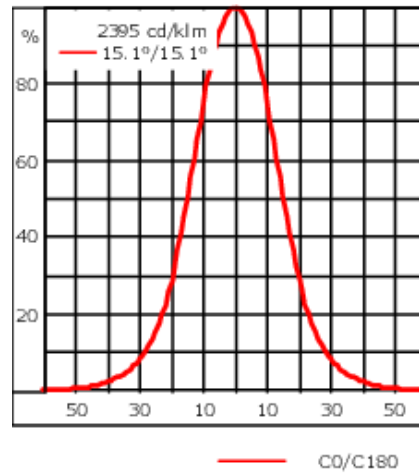
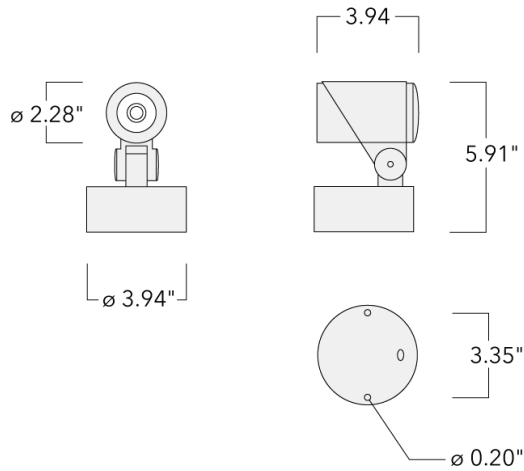

## Specifications

### Material description

Body	Marine-grade, die-cast aluminium alloy
Lens	Safety glass lens
Colors	<ul style="list-style-type: none"> <li><span style="display: inline-block; width: 15px; height: 15px; background-color: black; margin-right: 5px;"></span> RAL9004 Black</li> <li><span style="display: inline-block; width: 15px; height: 15px; background-color: grey; margin-right: 5px;"></span> RAL9007 Grey Metallic</li> <li><span style="display: inline-block; width: 15px; height: 15px; background-color: white; margin-right: 5px;"></span> RAL9016 White</li> <li><span style="display: inline-block; width: 15px; height: 15px; background-color: darkgrey; margin-right: 5px;"></span> RAL8019 Dark Bronze</li> </ul>
Gasket	Silicone CCG® Controlled Compression Gasket
Fasteners	PCS hardware
Ingress protection	IP66
Impact resistance	IK07
Corrosion resistance	5CE
Windage	0.107 ft <sup>2</sup>

### Electrical description

Power supply	120V AC/50-60 Hz (24V DC available upon request)
Driver / Ballast	Integral EC electronic converter (ON/OFF only)
Power factor	>0.9

#### WE-EF LIGHTING USA, LLC

410-D Keystone Drive, 15086 Warrendale, PA 15086 - Phone: +1 724 742 0030

customersupport.usa@we-ef.com - <https://we-ef.com/us>

Subject to technical changes and errors. - Generated on 10/23/2024

**145-7196**

**we-ef**

**FLC301 Surface mounted**

**Additional information**

---

Lifetime	Ta=25°/40° L90B10 > 90000h
Dimming	0-10V Dimming with Remote Driver only
Listings	ETL, UL-1598, CSA-C22.2#250.0. Suitable for Wet Locations.

---

**WE-EF LIGHTING USA, LLC**

410-D Keystone Drive, 15086 Warrendale, PA 15086 - Phone: +1 724 742 0030

customersupport.usa@we-ef.com - <https://we-ef.com/us>

Subject to technical changes and errors. - Generated on 10/23/2024

145-7196

**we-ef**

FLC301 Surface mounted

### Mounting Accessories

#### Short post EM

Description	Part ID	A	B	C1	D1	Weight (lb)
Short post EM1 for FLC301	145-9200	26	200	100	160	1.10

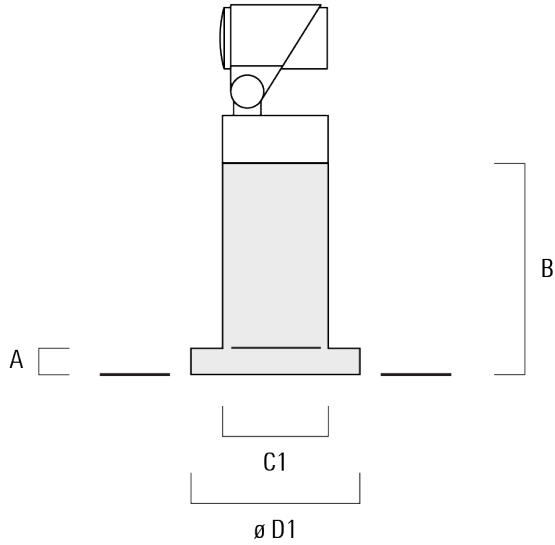

**WE-EF LIGHTING USA, LLC**

410-D Keystone Drive, 15086 Warrendale, PA 15086 - Phone: +1 724 742 0030

customersupport.usa@we-ef.com - <https://we-ef.com/us>

Subject to technical changes and errors. - Generated on 10/23/2024

145-7196

**we-ef**

FLC301 Surface mounted

## Optical Accessories

### Linear spread lens

---

Description	Part ID	C1
Linear spread lens IO-180	145-7229	42.5

---

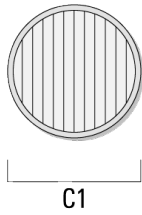

---

### Wallwash lens

**WE-EF LIGHTING USA, LLC**

410-D Keystone Drive, 15086 Warrendale, PA 15086 - Phone: +1 724 742 0030

customersupport.usa@we-ef.com - <https://we-ef.com/us>

Subject to technical changes and errors. - Generated on 10/23/2024

**FLC301 Surface mounted**

---

Description	Part ID	C1
Wallwash lens IO-20	145-7230	42.5

---

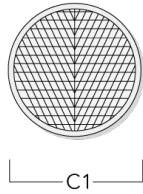

---

**Honeycomb louvre**

---

Description	Part ID	C1
Honeycomb louvre IW	145-7231	42.5

---

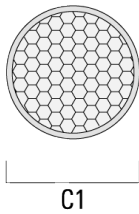

---

**Glare shield**

**WE-EF LIGHTING USA, LLC**

410-D Keystone Drive, 15086 Warrendale, PA 15086 - Phone: +1 724 742 0030

customersupport.usa@we-ef.com - <https://we-ef.com/us>

Subject to technical changes and errors. - Generated on 10/23/2024

**FLC301 Surface mounted**

---

Description	Part ID	A	C1
Glare shield ES	145-7232	20.5	58

---

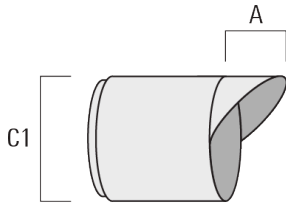

---

**Snoot**

---

Description	Part ID	A	C1
Snoot ET	145-7233	22.5	58

---

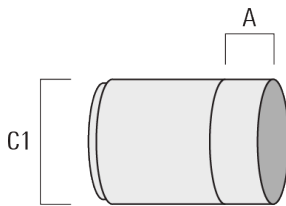

---

**WE-EF LIGHTING USA, LLC**

410-D Keystone Drive, 15086 Warrendale, PA 15086 - Phone: +1 724 742 0030

customersupport.usa@we-ef.com - <https://we-ef.com/us>

Subject to technical changes and errors. - Generated on 10/23/2024

**145-7196**

**we-ef**

**FLC301 Surface mounted**

## **Control**

### **DALI interface**

Description	Part ID
Low voltage DALI interface	0026

### **Electronic converter**

Description	Part ID
24VDC low voltage version	0025

**WE-EF LIGHTING USA, LLC**

410-D Keystone Drive, 15086 Warrendale, PA 15086 - Phone: +1 724 742 0030

customersupport.usa@we-ef.com - <https://we-ef.com/us>

Subject to technical changes and errors. - Generated on 10/23/2024



**145-7196**

**FLC301 Surface mounted**

**WE-EF LIGHTING USA, LLC**

410-D Keystone Drive, 15086 Warrendale, PA 15086

Phone: +1 724 742 0030

[customersupport.usa@we-ef.com](mailto:customersupport.usa@we-ef.com)

<https://we-ef.com/us>

Subject to technical changes and errors.

Generated on 10/23/2024

**we-ef**

---

A Fagerhult Group Company