

145-7243

we-ef

FLC301 Surface mounted



Description

IP66. IK07. Marine-grade, die-cast aluminium alloy. 5CE superior corrosion protection including PCS hardware. Safety glass lens. Silicone CCG® Controlled Compression Gasket. Luminaire is factory-sealed and does not need to be opened during installation.

Advanced thermal management protects LEDs while optimising lumens output. CAD-optimised optics for superior illumination and glare control.

Optical accessories are factory-installed. To be specified at time of ordering.

4W / 120V mains voltage version, ON-OFF Class I. Non-dimming.

6W / 24V DC low voltage version available upon request, ON-OFF Class III. Non-dimming.

Dimmable version can only be done with a remote driver (120-277V)

347V remote driver on request.

Weight	0.80 lb
Light distribution	symmetric, narrow beam [N]
Light source	LED-1/4W / 350 mA - 2700 K
CRI	80
Power supply	electronic gear
LEDs	1
Rated input power	5 W
Nominal Lumen (lm)	
LED Lumen	490
Total Lumen	490
Tj	85
Rated lumens (lm)	
LED Lumen	415.2
Total Lumen	415.2
Ta	25

WE-EF LIGHTING USA, LLC

410-D Keystone Drive, 15086 Warrendale, PA 15086 - Phone: +1 724 742 0030
customersupport.usa@we-ef.com - <https://we-ef.com/us>

Subject to technical changes and errors. - Generated on 11/23/2024

145-7243

we-ef

FLC301 Surface mounted

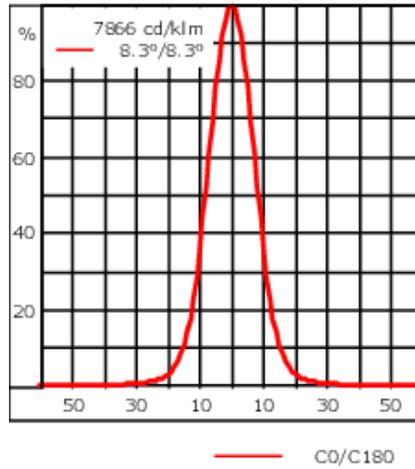
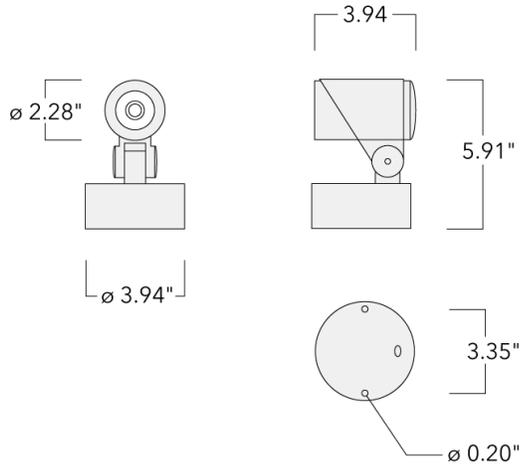

Specifications

Material description

Body	Marine-grade, die-cast aluminium alloy
Lens	Safety glass lens
Colors	<ul style="list-style-type: none"> RAL9004 Black RAL9007 Grey Metallic RAL9016 White RAL8019 Dark Bronze
Gasket	Silicone CCG [®] Controlled Compression Gasket
Fasteners	PCS hardware
Ingress protection	IP66
Impact resistance	IK07
Corrosion resistance	5CE
Windage	0.107 ft ²

Electrical description

Power supply	120V AC/50-60 Hz (24V DC available upon request)
Driver / Ballast	Integral EC electronic converter (ON/OFF only)
Power factor	>0.9

WE-EF LIGHTING USA, LLC

410-D Keystone Drive, 15086 Warrendale, PA 15086 - Phone: +1 724 742 0030

customersupport.usa@we-ef.com - <https://we-ef.com/us>

Subject to technical changes and errors. - Generated on 11/23/2024

145-7243

we-ef

FLC301 Surface mounted

Additional information

Lifetime	Ta=25°/40° L90B10 > 90000h
Dimming	0-10V Dimming with Remote Driver only
Listings	ETL, UL-1598, CSA-C22.2#250.0. Suitable for Wet Locations.

WE-EF LIGHTING USA, LLC

410-D Keystone Drive, 15086 Warrendale, PA 15086 - Phone: +1 724 742 0030
customersupport.usa@we-ef.com - <https://we-ef.com/us>
Subject to technical changes and errors. - Generated on 11/23/2024

145-7243

we-ef

FLC301 Surface mounted

Mounting Accessories

Short post EM

Description	Part ID	A	B	C1	D1	Weight (lb)
Short post EM1 for FLC301	145-9200	26	200	100	160	1.10

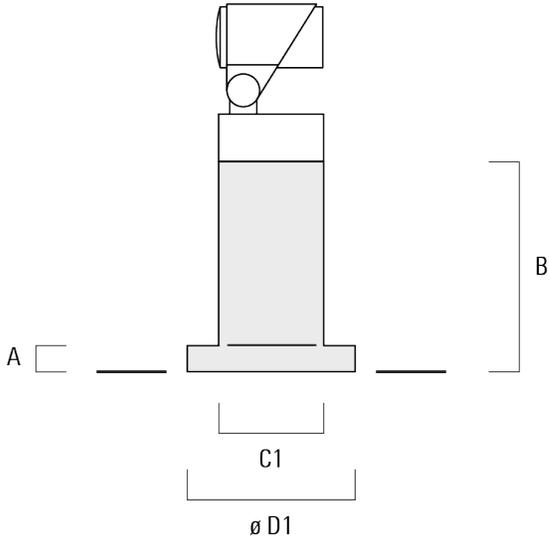

WE-EF LIGHTING USA, LLC

410-D Keystone Drive, 15086 Warrendale, PA 15086 - Phone: +1 724 742 0030
customersupport.usa@we-ef.com - <https://we-ef.com/us>
Subject to technical changes and errors. - Generated on 11/23/2024

145-7243

we-ef

FLC301 Surface mounted

Optical Accessories

Linear spread lens

Description	Part ID	C1
Linear spread lens IO-180	145-7229	42.5

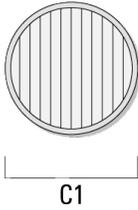

WE-EF LIGHTING USA, LLC

410-D Keystone Drive, 15086 Warrendale, PA 15086 - Phone: +1 724 742 0030
customersupport.usa@we-ef.com - <https://we-ef.com/us>
Subject to technical changes and errors. - Generated on 11/23/2024

145-7243

we-ef

FLC301 Surface mounted

Wallwash lens

Description	Part ID	C1
Wallwash lens IO-20	145-7230	42.5

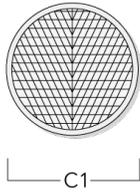

Honeycomb louvre

Description	Part ID	C1
Honeycomb louvre IW	145-7231	42.5

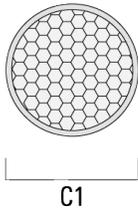

WE-EF LIGHTING USA, LLC

410-D Keystone Drive, 15086 Warrendale, PA 15086 - Phone: +1 724 742 0030

customersupport.usa@we-ef.com - <https://we-ef.com/us>

Subject to technical changes and errors. - Generated on 11/23/2024

FLC301 Surface mounted

Glare shield

Description	Part ID	A	C1
Glare shield ES	145-7232	20.5	58

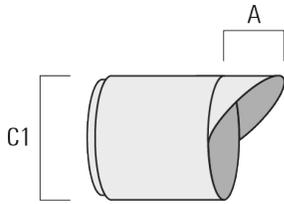

Snoot

Description	Part ID	A	C1
Snoot ET	145-7233	22.5	58

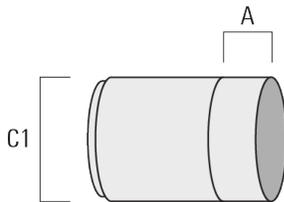

145-7243

we-ef

FLC301 Surface mounted

Control

DALI interface

Description	Part ID
Low voltage DALI interface	0026

Electronic converter

Description	Part ID
24VDC low voltage version	0025

WE-EF LIGHTING USA, LLC

410-D Keystone Drive, 15086 Warrendale, PA 15086 - Phone: +1 724 742 0030
customersupport.usa@we-ef.com - <https://we-ef.com/us>

Subject to technical changes and errors. - Generated on 11/23/2024