

### Description

IP66. IK07. Marine-grade, die-cast aluminium alloy. 5CE superior corrosion protection including PCS hardware. Safety glass lens. Silicone CCG® Controlled Compression Gasket. Luminaire is factory-sealed and does not need to be opened during installation.

Integral EC electronic converter. Advanced thermal management protects LEDs while optimising lumens output. CAD-optimised optics for superior illumination and glare control.

Mains voltage versions only, ON-OFF. Class I. 1-10 V analogue dimming or DALI interface available on request (converter in thermally-separated compartment); refer to accessory listings.

Including 0.4 m of flexible cable enclosed in a stainless conduit, in-line connector and mounting clamp for installation to RAIL66 mounting system.

Optical accessories are factory-installed. To be specified at time of ordering.

Weight	1.20 kg
Light distribution	symmetric, medium beam [M]
Light source	LED-1/4W / 350 mA - 2700 K
CRI	80
Power supply	EC
LEDs	1
Rated input power	5 W
<b>Nominal Lumen (lm)</b>	
LED Lumen	490
Total Lumen	490
Tj	85
<b>Rated lumens (lm)</b>	
LED Lumen	398.4
Total Lumen	398.4
Ta	25

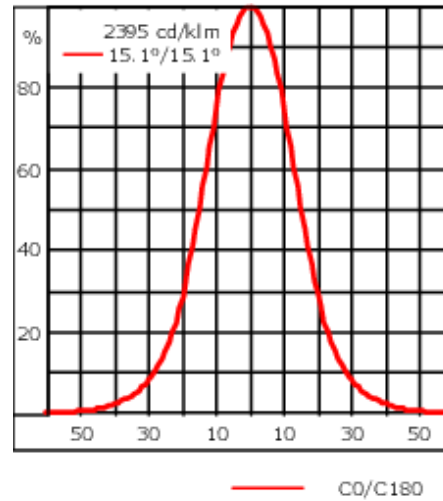
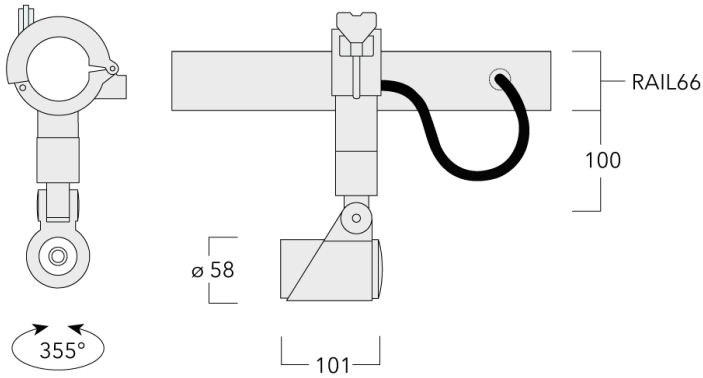

**Specifications**

**Material description**

Body	Marine-grade, die-cast aluminium alloy
Lens	Safety glass lens
Colours	<ul style="list-style-type: none"> <li><span style="display: inline-block; width: 15px; height: 15px; background-color: black; margin-right: 5px;"></span> RAL9004 Signal black</li> <li><span style="display: inline-block; width: 15px; height: 15px; background-color: #cccccc; margin-right: 5px;"></span> RAL9006 White aluminium</li> <li><span style="display: inline-block; width: 15px; height: 15px; background-color: #808080; margin-right: 5px;"></span> RAL9007 Grey aluminium</li> <li><span style="display: inline-block; width: 15px; height: 15px; background-color: #333333; margin-right: 5px;"></span> RAL7016 Anthracite grey</li> <li><span style="display: inline-block; width: 15px; height: 15px; background-color: #e0e0e0; margin-right: 5px;"></span> RAL9016 Traffic white</li> </ul>
Gasket	Silicone CCG® Controlled Compression Gasket
Fasteners	PCS hardware
Ingress protection	IP66
Impact resistance	IK07
Corrosion resistance	5CE

**Electrical description**

Driver / Ballast	Integral EC electronic converter
------------------	----------------------------------

**Additional information**

Lifetime	Ta=25° L90B10 > 90000h
Energy efficiency class	D-E (Light source)

**Mounting Accessories**

**Universal**

Description	Part ID	C1	C2	H1	M1	Weight (kg)	L1	L2
2 Mains outlets (L=1150)	310-9200	75	30	200	12	5.90	1150	1045

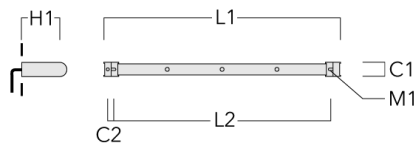

3 Mains outlets (L=1150)	310-9202	75	30	200	12	5.90	1150	1045
--------------------------	----------	----	----	-----	----	------	------	------

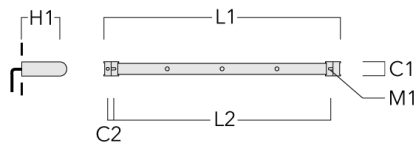

**FLC301 RAIL66**

Description	Part ID	C1	C2	H1	M1	Weight (kg)	L1	L2
3 Mains outlets (L=1650)	310-9210	75	30	200	12	7.20	1650	1545

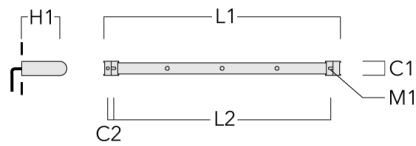

4 Mains outlets (L=1650)	310-9212	75	30	200	12	7.20	1650	1545
--------------------------	----------	----	----	-----	----	------	------	------

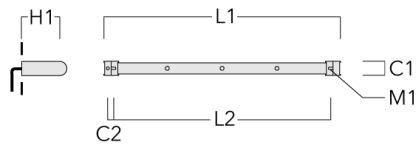

**FLC301 RAIL66**

Description	Part ID	C1	C2	H1	M1	Weight (kg)	L1	L2
4 Mains outlets (L=2150)	310-9220	75	30	200	12	8.50	2150	2045

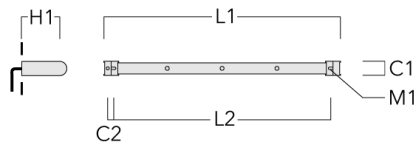

6 Mains outlets (L=2150)	310-9222	75	30	200	12	8.50	2150	2045
--------------------------	----------	----	----	-----	----	------	------	------

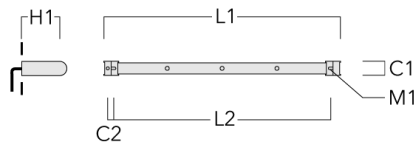

**FLC301 RAIL66**

**Flat Surface Fitters**

Description	Part ID	C1	C2	D1	D2	L	M1	Weight (kg)
Surface fitters (pair)	310-9290	20	30	180	140	1070	9	1.70

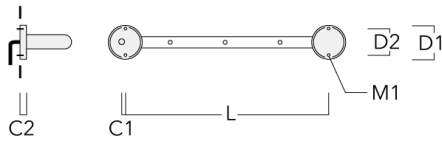

**Column Fitters**

Description	Part ID	C1	C2	L	M1	Weight (kg)
Column fitters (pair)	310-9294	30	100	1115	12	0.90

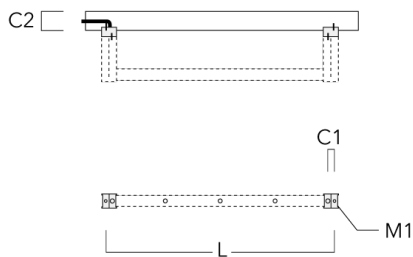

## Optical Accessories

### Linear spread lens

Description	Part ID	C1
Linear spread lens IO-180	145-7229	42.5

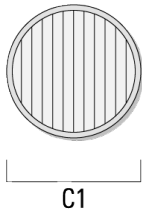

### Wallwash lens

Description	Part ID	C1
IO-20-WW-FLC301-LED	145-7230	42.5

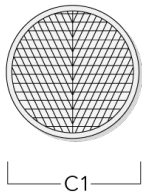

**Honeycomb louvre**

Description	Part ID	C1
Honeycomb louvre IW	145-7231	42.5

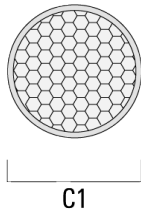

**Glare shield**

Description	Part ID	A	C1
Glare shield ES	145-7232	20.5	58

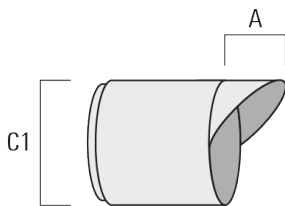



**Snoot**

Description	Part ID	A	C1
Snoot ET	145-7233	22.5	58

