

## FLC301 Spigot mounted



### Description

IP66. IK07. Marine-grade, die-cast aluminium alloy. 5CE superior corrosion protection including PCS hardware. Safety glass lens. Silicone CCG® Controlled Compression Gasket. Luminaire is factory-sealed and does not need to be opened during installation.

Advanced thermal management protects LEDs while optimising lumens output. CAD-optimised optics for superior illumination and glare control. Including 1.5 m of flexible PVC free cable.

Mains voltage versions, ON-OFF Class I. Integral EC electronic converter.

24VDC low voltage versions, ON-OFF or DALI Class II can be ordered remote gear box 145-7234.

24VDC low voltage versions, ON-OFF Class III. DALI (only 4W available) Class I.

Remote 24VDC power supply to be ordered separately.

Optical accessories are factory-installed. To be specified at time of ordering.

|                    |                                  |
|--------------------|----------------------------------|
| Weight             | 0.70 kg                          |
| Light distribution | symmetric, very narrow beam [EE] |
| Light source       | LED-1/4W / 350 mA - 2700 K       |
| CRI                | 80                               |
| Power supply       | EC                               |
| LEDs               | 1                                |
| Rated input power  | 5 W                              |

### Nominal Lumen (lm)

|                |     |
|----------------|-----|
| LED Lumen      | 490 |
| Total Lumen    | 490 |
| T <sub>j</sub> | 85  |

### Rated lumens (lm)

|                |       |
|----------------|-------|
| LED Lumen      | 415.5 |
| Total Lumen    | 415.5 |
| T <sub>a</sub> | 25    |

### WE-EF LIGHTING (Thailand) Co., Ltd.

57 Moo 5, Kingkaew Rd., Bangplee, 10540 Samutprakarn - Phone: +66 2 738 96 20 - Fax: +66 2 738 96 29

<https://we-ef.com/asia>

Subject to technical changes and errors. - Generated on 23/11/2024

145-7186+0025



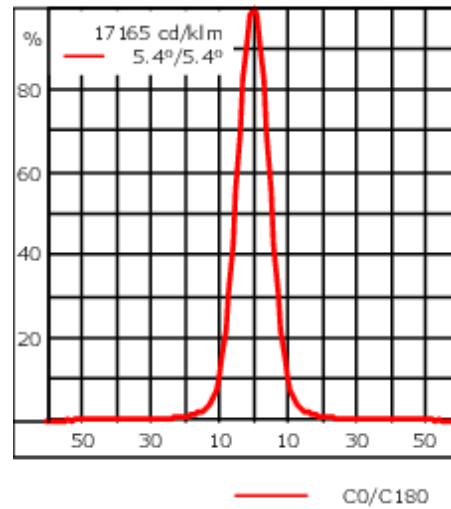
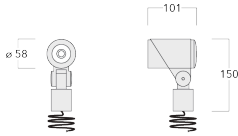

FLC301 Spigot mounted

**we-ef**



## Specifications

### Material description

|                      |  |
|----------------------|--|
| Body                 | Marine-grade, die-cast aluminium alloy   |
| Lens                 | Safety glass lens  |
| Colours              |  RAL9004 Signal black<br> RAL9007 Grey aluminium<br> RAL7016 Anthracite grey<br> RAL9016 Traffic white |
| Gasket               | Silicone CCG® Controlled Compression Gasket  |
| Fasteners            | PCS hardware   |
| Ingress protection   | IP66   |
| Impact resistance    | IK07   |
| Corrosion resistance | 5CE  |
| Windage              | 0.015 m <sup>2</sup>   |

### Electrical description

|                  |  |
|------------------|--|
| Driver / Ballast | Integral EC electronic converter (mains voltage). Integral ED electronic driver (24VDC low voltage). |
| Power factor     | >0.9   |

### Additional information

|          |                                     |
|----------|-------------------------------------|
| Lifetime | T <sub>a</sub> =25° L90B10 > 90000h |
|----------|-------------------------------------|

**WE-EF LIGHTING (Thailand) Co., Ltd.**

57 Moo 5, Kingkaew Rd., Bangplee, 10540 Samutprakarn - Phone: +66 2 738 96 20 - Fax: +66 2 738 96 29

<https://we-ef.com/asia>

Subject to technical changes and errors. - Generated on 23/11/2024

**FLC301 Spigot mounted**

**Electrical Accessories**

**Gear box**

| Description     | Part ID  | Additional information       | A  | B  | C1  | Weight (kg) |
|-----------------|----------|------------------------------|----|----|-----|-------------|
| Gear box CGB320 | 145-7234 | Remote gear box for CLASS II | 39 | 82 | 142 | 0.40        |

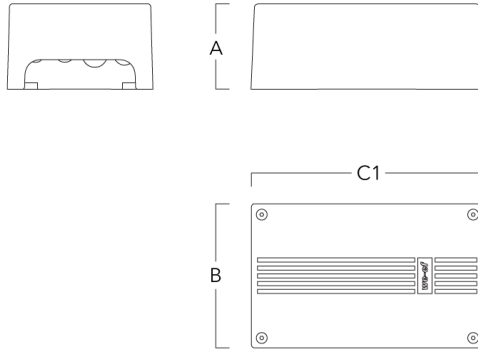

**FLC301 Spigot mounted**

**Mounting Accessories**

**Flat surface and Column fitter**

| Description          | Part ID  | A  | B | Weight (kg) |
|----------------------|----------|----|---|-------------|
| Column fitter FLC300 | 145-9536 | 70 |   | 0.20        |

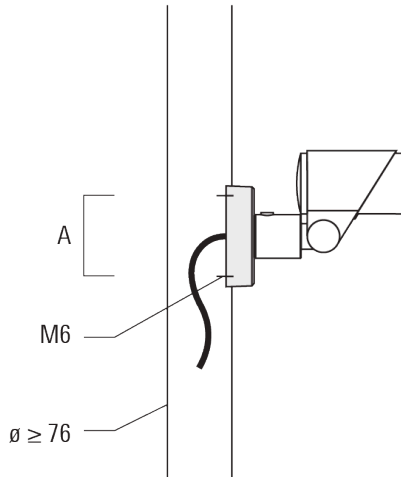

|                            |          |     |    |      |
|----------------------------|----------|-----|----|------|
| Flat surface fitter FLC300 | 145-9535 | 100 | 85 | 0.20 |
|----------------------------|----------|-----|----|------|

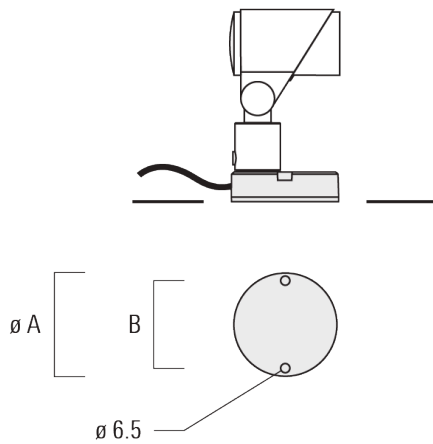

**FLC301 Spigot mounted**

**Ground spike**

| Description                 | Part ID  | A   | Weight (kg) |
|-----------------------------|----------|-----|-------------|
| Ground spike EF1 for FLC300 | 310-9102 | 270 | 1.20        |



**Junction box**

| Description                      | Part ID  | A   | B  | C1  | D1 | Weight (kg) |
|----------------------------------|----------|-----|----|-----|----|-------------|
| Junction box JB1 with side entry | 310-9002 | 107 | 67 | 135 | 67 | 1.20        |



145-7186+0025

**we-ef**

**FLC301 Spigot mounted**

| Description                      | Part ID  | A   | B  | C1  | D1 | Weight (kg) |
|----------------------------------|----------|-----|----|-----|----|-------------|
| Junction box JB1 with wall entry | 310-9025 | 107 | 67 | 135 | 67 | 1.10        |

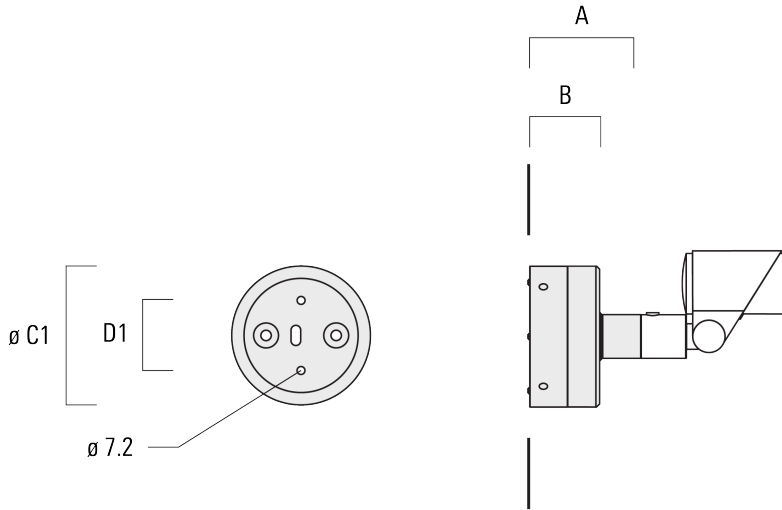

145-7186+0025

FLC301 Spigot mounted

**we-ef**

## Optical Accessories

### Linear spread lens

| Description               | Part ID  | C1   |
|---------------------------|----------|------|
| Linear spread lens IO-180 | 145-7229 | 42.5 |

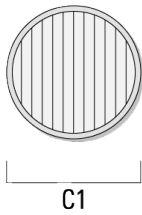

### Wallwash lens

| Description         | Part ID  | C1   |
|---------------------|----------|------|
| Wallwash lens IO-20 | 145-7230 | 42.5 |

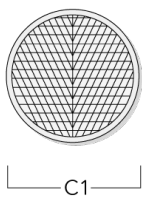

**WE-EF LIGHTING (Thailand) Co., Ltd.**

57 Moo 5, Kingkaew Rd., Bangplee, 10540 Samutprakarn - Phone: +66 2 738 96 20 - Fax: +66 2 738 96 29

<https://we-ef.com/asia>

Subject to technical changes and errors. - Generated on 23/11/2024

**FLC301 Spigot mounted**

**Honeycomb louvre**

| Description         | Part ID  | C1   |
|---------------------|----------|------|
| Honeycomb louvre IW | 145-7231 | 42.5 |

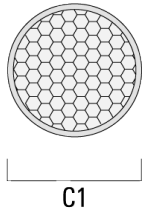

**Glare shield**

| Description     | Part ID  | A    | C1 |
|-----------------|----------|------|----|
| Glare shield ES | 145-7232 | 20.5 | 58 |

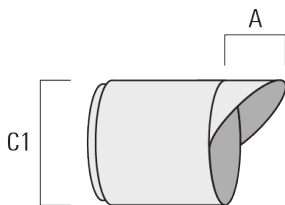



145-7186+0025

**we-ef**

**FLC301 Spigot mounted**

**Snoot**

---

| Description | Part ID  | A    | C1 |
|-------------|----------|------|----|
| Snoot ET    | 145-7233 | 22.5 | 58 |

---

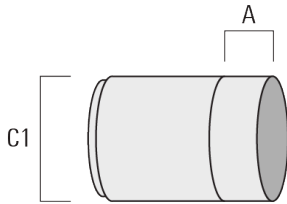

---

**WE-EF LIGHTING (Thailand) Co., Ltd.**

57 Moo 5, Kingkaew Rd., Bangplee, 10540 Samutprakarn - Phone: +66 2 738 96 20 - Fax: +66 2 738 96 29

<https://we-ef.com/asia>

Subject to technical changes and errors. - Generated on 23/11/2024

**145-7186+0025**

**FLC301 Spigot mounted**

**we-ef**

## **Control**

### **DALI interface**

| Description                | Part ID |
|----------------------------|---------|
| Low voltage DALI interface | 0026    |

**WE-EF LIGHTING (Thailand) Co., Ltd.**

57 Moo 5, Kingkaew Rd., Bangplee, 10540 Samutprakarn - Phone: +66 2 738 96 20 - Fax: +66 2 738 96 29

<https://we-ef.com/asia>

Subject to technical changes and errors. - Generated on 23/11/2024