



Description

IP67, Class I. IK09. Marine-grade, all aluminium construction. 5CE superior corrosion protection including PCS hardware. Silicone rubber gasket. PMMA main lens. Linear PMMA LED lens. 1.2 m connecting cable, UV stabilized, PVC free. Luminaire is factory sealed and does not need to be opened during installation and can be tilted up to 180°. Integral LED driver with DALI interface. Optional 2200 K version available. To be specified at time of ordering.

Separate LED driver on request.

Weight	2.45 kg
Light distribution	symmetric linear, wide beam [LB/IW]
Light source	LED-32/20W / 225 mA - 4000 K
CRI	80
Power supply	EC
LEDs	32
Rated input power	23.5 W
Nominal Lumen (lm)	
LED Lumen	90
Total Lumen	2880
T _j	85
Rated lumens (lm)	
LED Lumen	26.6
Total Lumen	851.5
T _a	25

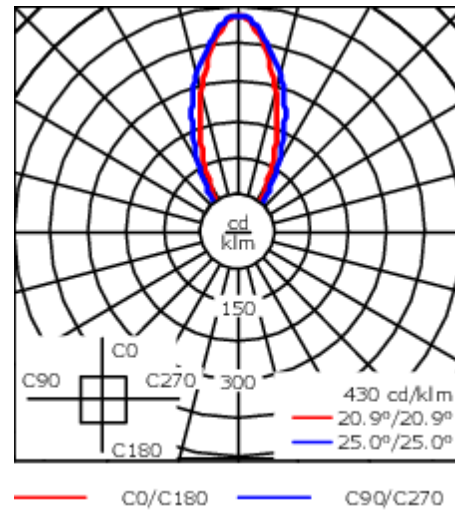
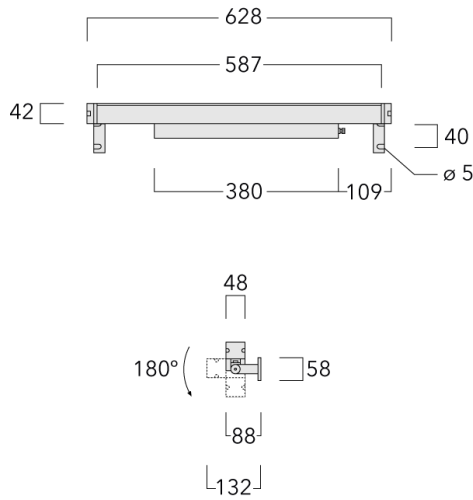

Specifications

Material description

Body	Marine-grade, all-aluminium construction
Lens	PMMA
Colours	<div style="display: flex; align-items: center;"> <div style="width: 20px; height: 15px; background-color: black; margin-right: 5px;"></div> RAL9004 Signal black </div> <div style="display: flex; align-items: center; margin-top: 5px;"> <div style="width: 20px; height: 15px; background-color: #cccccc; margin-right: 5px;"></div> RAL9006 White aluminium </div> <div style="display: flex; align-items: center; margin-top: 5px;"> <div style="width: 20px; height: 15px; background-color: #808080; margin-right: 5px;"></div> RAL9007 Grey aluminium </div> <div style="display: flex; align-items: center; margin-top: 5px;"> <div style="width: 20px; height: 15px; background-color: #333333; margin-right: 5px;"></div> RAL7016 Anthracite grey </div> <div style="display: flex; align-items: center; margin-top: 5px;"> <div style="width: 20px; height: 15px; background-color: #e0e0e0; margin-right: 5px;"></div> RAL9016 Traffic white </div>
Gasket	Silicone rubber gasket
Fasteners	PCS Polymer Coated Stainless Steel Hardware
Ingress protection	IP67
Impact resistance	IK09
Corrosion resistance	5CE

Electrical description

Power supply	220-240V / 50-60 Hz
Driver / Ballast	Integral LED driver with DALI Interface

Additional information

Lifetime	Ta=25° L90B10 > 90000h
Energy efficiency class	D (Light source)