



Description

IP67, Class I. IK09. Marine-grade, all aluminium construction. 5CE superior corrosion protection including PCS hardware. Silicone rubber gasket. PMMA main lens. Linear PMMA LED lens. 1.2 m connecting cable, UV stabilized, PVC free. Luminaire is factory sealed and does not need to be opened during installation and can be tilted up to 180°. Integral LED driver with DALI interface.

Separate LED driver on request.

Weight	3.25 kg
Light distribution	symmetric linear, medium beam [LM/IW]
Light source	LED-48/30W / 225 mA - 2700 K
CRI	80
Power supply	EC
LEDs	48
Rated input power	33.5 W
Nominal Lumen (lm)	
LED Lumen	90
Total Lumen	4320
T _j	85
Rated lumens (lm)	
LED Lumen	33.4
Total Lumen	1603.2
T _a	25

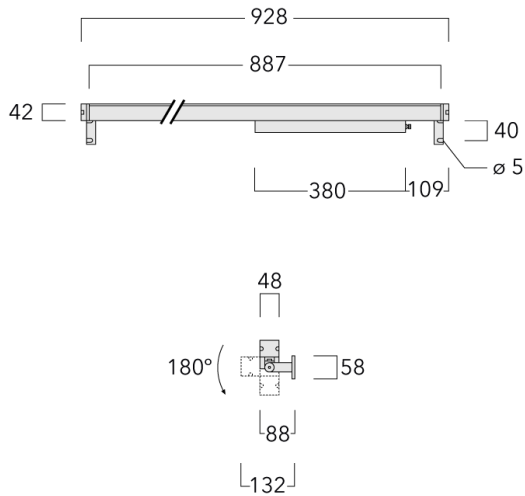

Specifications

Material description

Body	Marine-grade, all-aluminium construction
Lens	PMMA
Colours	<div style="display: flex; align-items: center;"> <div style="width: 20px; height: 15px; background-color: black; margin-right: 5px;"></div> <div>RAL9004 Signal black</div> </div> <div style="display: flex; align-items: center; margin-top: 5px;"> <div style="width: 20px; height: 15px; background-color: #cccccc; margin-right: 5px;"></div> <div>RAL9006 White aluminium</div> </div> <div style="display: flex; align-items: center; margin-top: 5px;"> <div style="width: 20px; height: 15px; background-color: #808080; margin-right: 5px;"></div> <div>RAL9007 Grey aluminium</div> </div> <div style="display: flex; align-items: center; margin-top: 5px;"> <div style="width: 20px; height: 15px; background-color: #333333; margin-right: 5px;"></div> <div>RAL7016 Anthracite grey</div> </div> <div style="display: flex; align-items: center; margin-top: 5px;"> <div style="width: 20px; height: 15px; background-color: #e0e0e0; margin-right: 5px;"></div> <div>RAL9016 Traffic white</div> </div>
Gasket	Silicone rubber gasket
Fasteners	PCS Polymer Coated Stainless Steel Hardware
Ingress protection	IP67
Impact resistance	IK09
Corrosion resistance	5CE

Electrical description

Power supply	220-240V / 50-60 Hz
Driver / Ballast	Integral LED driver with DALI Interface

Additional information

Lifetime	Ta=25° L90B10 > 90000h
Energy efficiency class	D (Light source)