



**Description**

IP67. Class I. IK09. Marine-grade, all aluminum construction. 5CE superior corrosion protection including PCS hardware. Silicone CCG® Controlled Compression Gasket. Linear PMMA LED lens, PMMA cover. 4 ft connecting cable, UV stabilized, PVC free. Integral LED driver; separate LED driver available instead, on request at time of order. 0-10V Dimming comes standard with luminaire. Luminaire is factory-sealed and does not need to be opened during installation and can be tilted up to 180°.

Specify product with 7 Digit product code - Finish Color. Accessories, such as mounting, optical, and electrical, must be specified separately.

Example: XXX-XXXX-9004 (Black)  
+ XXX-XXXX (Accessory 1)

Weight	8.82 lb
Light distribution	symmetric linear, wide beam [LW/ IW]
Light source	LED-64/40W / 225 mA - 2700 K
CRI	80
Power supply	electronic gear
LEDs	64
Rated input power	44 W

**Nominal Lumen (lm)**

LED Lumen	90
Total Lumen	5760
Tj	85

**Rated lumens (lm)**

LED Lumen	26.6
Total Lumen	1703
Ta	25

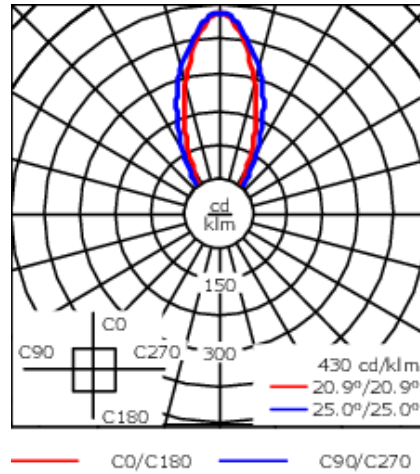
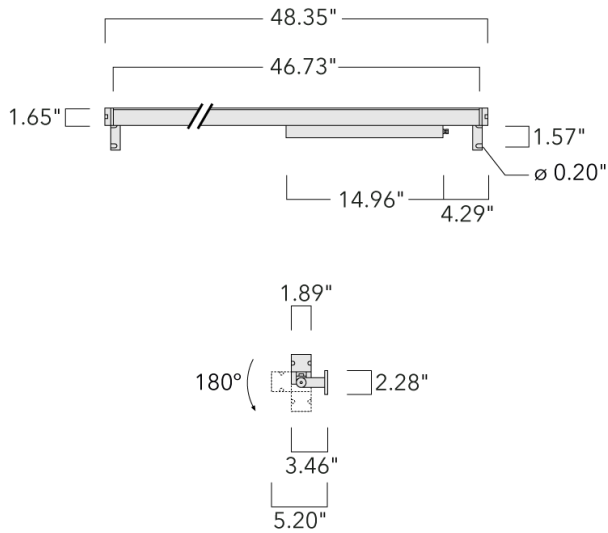

## Specifications

### Material description

Body	Marine-grade, all-aluminium construction
Lens	PMMA
Colors	<div style="display: flex; align-items: center;"> <div style="width: 20px; height: 10px; background-color: black; margin-right: 5px;"></div> <span>RAL9004 Black</span> </div> <div style="display: flex; align-items: center; margin-top: 5px;"> <div style="width: 20px; height: 10px; background-color: grey; margin-right: 5px;"></div> <span>RAL9007 Grey Metallic</span> </div> <div style="display: flex; align-items: center; margin-top: 5px;"> <div style="width: 20px; height: 10px; background-color: white; margin-right: 5px;"></div> <span>RAL9016 White</span> </div> <div style="display: flex; align-items: center; margin-top: 5px;"> <div style="width: 20px; height: 10px; background-color: darkgrey; margin-right: 5px;"></div> <span>RAL8019 Dark Bronze</span> </div>
Gasket	Silicone rubber gasket
Fasteners	PCS Polymer Coated Stainless Steel Hardware
Ingress protection	IP67
Impact resistance	IK09
Corrosion resistance	5CE

### Electrical description

Power supply	Integral [ECG] electronic driver 120V-277V. 0-10V dimmable, to be specified with order.
Driver / Ballast	LED driver with 0-10V Interface

**WE-EF LIGHTING USA, LLC**

410-D Keystone Drive, 15086 Warrendale, PA 15086 - Phone: +1 724 742 0030

customersupport.usa@we-ef.com - <https://we-ef.com/us>

Subject to technical changes and errors. - Generated on 11/23/2024

**187-0591**

**we-ef**

**VLR140**

**Additional information**

---

Lifetime	Ta=25°/40° L90B10 > 90000h
Listings	ETL Listed. Suitable for wet locations.

---

**WE-EF LIGHTING USA, LLC**

410-D Keystone Drive, 15086 Warrendale, PA 15086 - Phone: +1 724 742 0030  
customersupport.usa@we-ef.com - <https://we-ef.com/us>  
Subject to technical changes and errors. - Generated on 11/23/2024