



Description

IP67. Class I. IK09. Marine-grade, all aluminum construction. 5CE superior corrosion protection including PCS hardware. Silicone CCG® Controlled Compression Gasket. Linear PMMA LED lens, PMMA cover. 4 ft connecting cable, UV stabilized, PVC free. Integral LED driver; separate LED driver available instead, on request at time of order. 0-10V Dimming comes standard with luminaire. Luminaire is factory-sealed and does not need to be opened during installation and can be tilted up to 180°.

Specify product with 7 Digit product code - Finish Color. Accessories, such as mounting, optical, and electrical, must be specified separately.

Example: XXX-XXXX-9004 (Black)
+ XXX-XXXX (Accessory 1)

Weight	8.82 lb
Light distribution	symmetric linear, narrow beam [LN/IW]
Light source	LED-64/40W / 225 mA - 4000 K
CRI	80
Power supply	electronic gear
LEDs	64
Rated input power	44 W

Nominal Lumen (lm)

LED Lumen	90
Total Lumen	5760
Tj	85

Rated lumens (lm)

LED Lumen	34.8
Total Lumen	2227.4
Ta	25

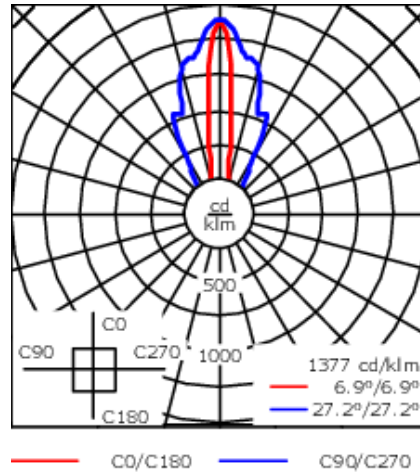
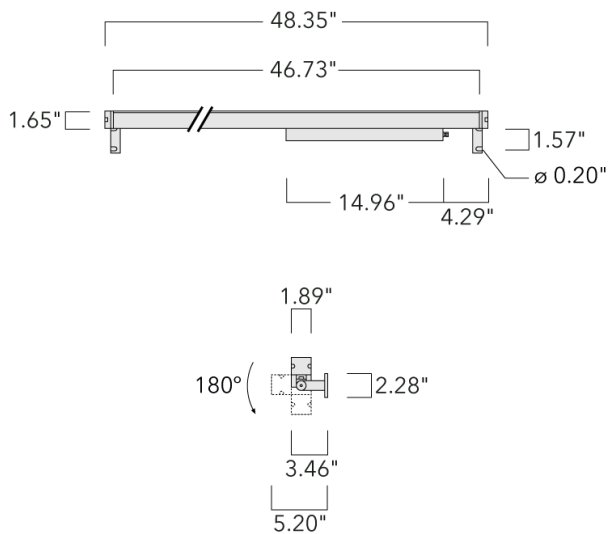

Specifications

Material description

Body	Marine-grade, all-aluminium construction
Lens	PMMA
Colors	<div style="display: flex; flex-direction: column; gap: 5px;"> <div> RAL9004 Black</div> <div> RAL9007 Grey Metallic</div> <div> RAL9016 White</div> <div> RAL8019 Dark Bronze</div> </div>
Gasket	Silicone rubber gasket
Fasteners	PCS Polymer Coated Stainless Steel Hardware
Ingress protection	IP67
Impact resistance	IK09
Corrosion resistance	5CE

Electrical description

Power supply	Integral [ECG] electronic driver 120V-277V. 0-10V dimmable, to be specified with order.
Driver / Ballast	LED driver with 0-10V Interface

WE-EF LIGHTING USA, LLC

410-D Keystone Drive, 15086 Warrendale, PA 15086 - Phone: +1 724 742 0030
 customersupport.usa@we-ef.com - <https://we-ef.com/us>
 Subject to technical changes and errors. - Generated on 11/23/2024

187-0511

we-ef

VLR140

Additional information

Lifetime	Ta=25°/40° L90B10 > 90000h
Listings	ETL Listed. Suitable for wet locations.

WE-EF LIGHTING USA, LLC

410-D Keystone Drive, 15086 Warrendale, PA 15086 - Phone: +1 724 742 0030
customersupport.usa@we-ef.com - <https://we-ef.com/us>
Subject to technical changes and errors. - Generated on 11/23/2024