

ETC130-GB LED



Description

IP69K. Class I. IK10+. Stainless steel construction. PCS hardware. Optional with Anti-Slip ceramic Coating ASC to DIN 51130 (Trip Classification 10) available on request. Silicone CCG® Controlled Compression Gasket. Safety glass lens; max load 5.5 tons (11,000 lbs). Luminaire can be driven over at low speed. Cable gland with spiral cable bending protection. Factory-sealed termination chamber complete with cable gland and 3 ft of flexible PVC-free, gel-impregnated anti-wicking cable. CAD-optimized optics for superior illumination and glare control. Integral driver in thermally separated compartment. OLC® One LED Concept. Factory-installed LED circuit board. 0-10V Dimming comes standard with luminaire. Gimbal mounted, 360° rotatable and 30° tiltable. 'No tool' removable gear/lens tray.

Suitable for flush installation in concrete or earth. The concrete-pour installation blockout is supplied as standard with luminaire.

Specify product with 7 Digit product code - Finish Color. Accessories, such as mounting, optical, and electrical, must be specified separately.

Example: XXX-XXXX-9004 (Black)

+ XXX-XXXX (Accessory 1)

Weight	18.20 lb
Light distribution	linear spread, very narrow beam [VN]
Light source	LED-12/18W / 500 mA - 2700 K
CRI	80
Power supply	electronic gear
LEDs	12
Rated input power	21 W

Nominal Lumen (lm)

LED Lumen	200
Total Lumen	2400
Tj	85

Delivered lumens (lm)

LED Lumen	153
Total Lumen	1835.8
Ta	25

WE-EF LIGHTING USA, LLC

410-D Keystone Drive, 15086 Warrendale, PA 15086 - Phone: +1 724 742 0030

customersupport.usa@we-ef.com - <https://we-ef.com/us>

Subject to technical changes and errors. - Generated on 10/05/2025

ETC130-GB LED

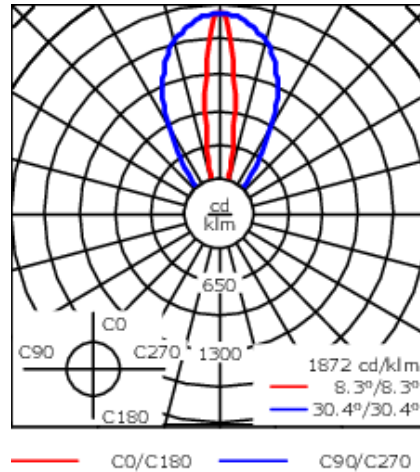
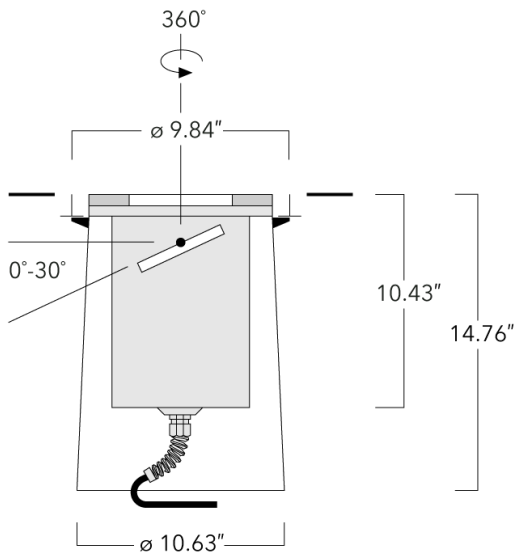

Specifications

Material description

Body	Luminaire body constructed of deep drawn stainless steel. Outer housing composite material.
Lens	5/8" thick clear tempered glass lens. Max. load 5000kg/11,000 lbs.
Colors	 Stainless Steel
Gasket	Silicone rubber gasket
Fasteners	PCS polymer coated stainless steel
Ingress protection	IP69K - HIGHEST PROTECTION RATING AVAILABLE
Impact resistance	IK10+
Corrosion resistance	5CE

Electrical description

Power supply	Integral [ECG] electronic driver 120V-277V. 0-10V dimmable, to be specified with order.
Driver / Ballast	Integral [ECG] electronic driver 120V-277V. 0-10V dimmable, to be specified with order.
Termination	Factory sealed termination chamber
Power factor	> 0.9
Surge protection	Integral 10kV Surge Protector

WE-EF LIGHTING USA, LLC

410-D Keystone Drive, 15086 Warrendale, PA 15086 - Phone: +1 724 742 0030
 customersupport.usa@we-ef.com - <https://we-ef.com/us>
 Subject to technical changes and errors. - Generated on 10/05/2025

185-3141+185-2632

we-ef

ETC130-GB LED

Additional information

Lifetime	Ta=25°/40° L90B10 > 90000h
Dimming	0-10V available in request. Must be factory fitted.
Listings	ETL, UL-1598, CSA-C22.2#250.0. Suitable for Wet Locations.

WE-EF LIGHTING USA, LLC

410-D Keystone Drive, 15086 Warrendale, PA 15086 - Phone: +1 724 742 0030
customersupport.usa@we-ef.com - <https://we-ef.com/us>
Subject to technical changes and errors. - Generated on 10/05/2025

185-3141+185-2632

we-ef

ETC130-GB LED

Electrical Accessories

Sealable junction box

Description	Part ID	C1	M1	M2
Sealable junction box SJB 130	185-1624	5.75	Ø 0.39	Ø 0.47 - 0.75

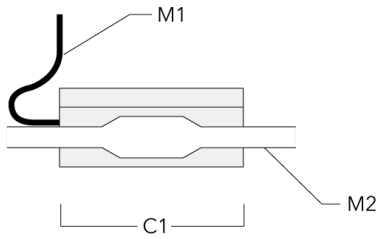

WE-EF LIGHTING USA, LLC

410-D Keystone Drive, 15086 Warrendale, PA 15086 - Phone: +1 724 742 0030
customersupport.usa@we-ef.com - <https://we-ef.com/us>

Subject to technical changes and errors. - Generated on 10/05/2025

ETC130-GB LED

Optical Accessories

Linear spread lens

Description	Part ID	Additional information	C1
IO-180 ETC130/330-GB LED	185-2632		3.94

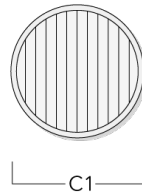

IO-180-DAC120-LED	134-2000	Broadens light distribution in one plane only. Ideally suitable for [M][VN][VNS]. Does not fit in combination with [W] lens. A maximum of one internal optical accessory. Internal component, factory installed.	4.05
-------------------	----------	---	------

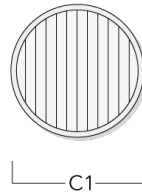

WE-EF LIGHTING USA, LLC

ETC130-GB LED

Softening Lens

Description	Part ID	C1
I0-360-ETC130-GB-LED	185-2866	3.86

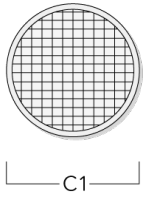

Honeycomb louvre

Description	Part ID	C1
IW-ETC130/330-GB-LED	185-2870	3.86

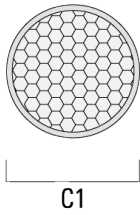

WE-EF LIGHTING USA, LLC

410-D Keystone Drive, 15086 Warrendale, PA 15086 - Phone: +1 724 742 0030
customersupport.usa@we-ef.com - <https://we-ef.com/us>
Subject to technical changes and errors. - Generated on 10/05/2025