

105-7120-70

RMT320 LED Two-sided

we-ef

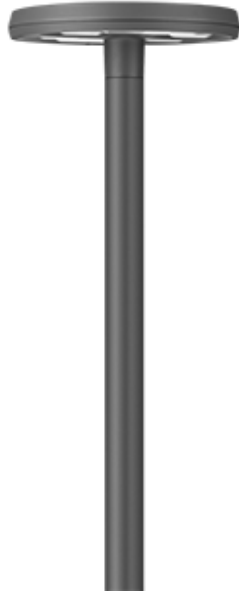

Description

IP66. Post top LED luminaire. Integrated heat sinks. Easy removal and replacement of LED board. CAD-optimized OLC PMMA lens for multi-layer illumination and superior glare control.

Weight	8.00 lb
Light distribution	[R65] Type IV Medium
Light source	LED-12/24W / 700 mA - 2700 K
CRI	70
Power supply	electronic gear
LEDs	12
Rated input power	27 W
Nominal Lumen (lm)	
LED Lumen	290
Total Lumen	3480
Tj	85
Rated lumens (lm)	
LED Lumen	238.1
Total Lumen	2857.4
Ta	25

WE-EF LIGHTING USA, LLC

410-D Keystone Drive, 15086 Warrendale, PA 15086 - Phone: +1 724 742 0030
customersupport.usa@we-ef.com - <https://we-ef.com/us>
Subject to technical changes and errors. - Generated on 11/23/2024

105-7120-70



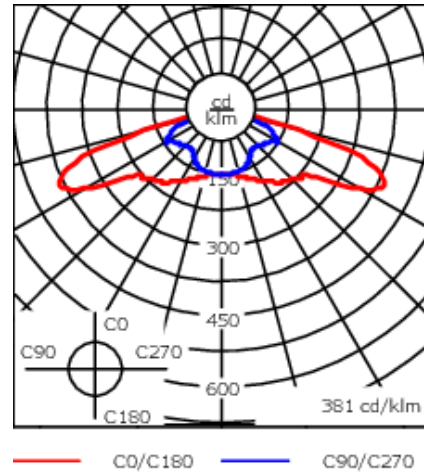
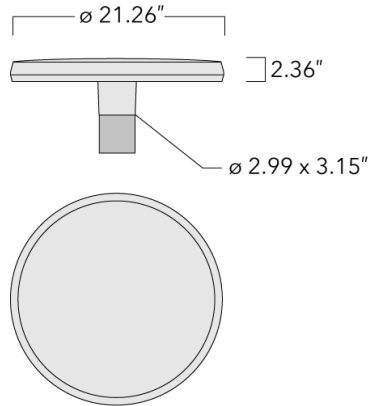

RMT320 LED Two-sided

we-ef



Specifications

Material description

Body	Marine-grade, die-cast aluminium alloy
Lens	RFC® Reflection Free Contour technology
Colors	 RAL9004 Black  RAL9007 Grey Metallic  RAL9016 White  RAL8019 Dark Bronze
Gasket	Silicone CCG® Controlled Compression Gasket
Fasteners	PCS Polymer Coated Stainless Steel Hardware
Ingress protection	IP66
Impact resistance	IK09
Corrosion resistance	5CE

Electrical description

Power supply	220-240V / 50-60 Hz
Driver / Ballast	Integral EC electronic converter
Power factor	> 0.9

WE-EF LIGHTING USA, LLC

410-D Keystone Drive, 15086 Warrendale, PA 15086 - Phone: +1 724 742 0030

customersupport.usa@we-ef.com - <https://we-ef.com/us>

Subject to technical changes and errors. - Generated on 11/23/2024

105-7120-70

we-ef

RMT320 LED Two-sided

Additional information

Lifetime

Ta=25°/40° L90B10 > 90000h

WE-EF LIGHTING USA, LLC

410-D Keystone Drive, 15086 Warrendale, PA 15086 - Phone: +1 724 742 0030

customersupport.usa@we-ef.com - <https://we-ef.com/us>

Subject to technical changes and errors. - Generated on 11/23/2024