

105-9925-70

RMT320 LED Two-sided

we-ef

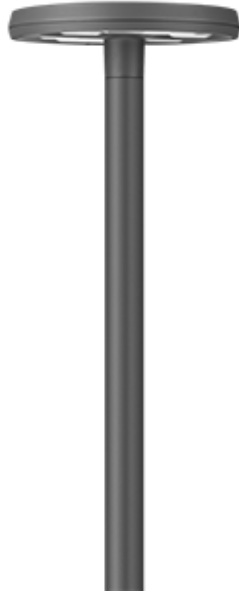

Description

IP66. Post top LED luminaire. Integrated heat sinks. Easy removal and replacement of LED board. CAD-optimized OLC PMMA lens for multi-layer illumination and superior glare control.

| | |
|---------------------------|------------------------------|
| Weight | 0.00 lb |
| Light distribution | [R65] Type IV Medium |
| Light source | LED-12/24W / 700 mA - 4000 K |
| CRI | 70 |
| Power supply | electronic gear |
| LEDs | 12 |
| Rated input power | 27 W |
| Nominal Lumen (lm) | |
| LED Lumen | 350 |
| Total Lumen | 4200 |
| Tj | 85 |
| Rated lumens (lm) | |
| LED Lumen | 287.4 |
| Total Lumen | 3448.6 |
| Ta | 25 |

WE-EF LIGHTING USA, LLC

410-D Keystone Drive, 15086 Warrendale, PA 15086 - Phone: +1 724 742 0030
customersupport.usa@we-ef.com - <https://we-ef.com/us>
Subject to technical changes and errors. - Generated on 11/23/2024

105-9925-70



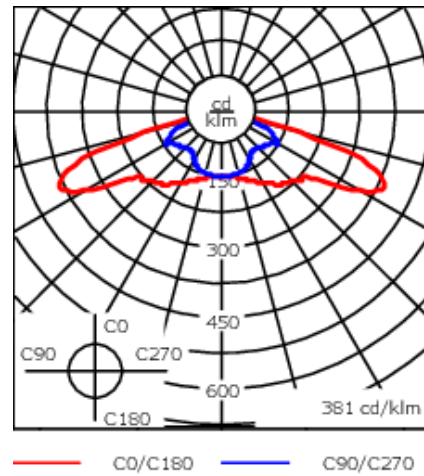
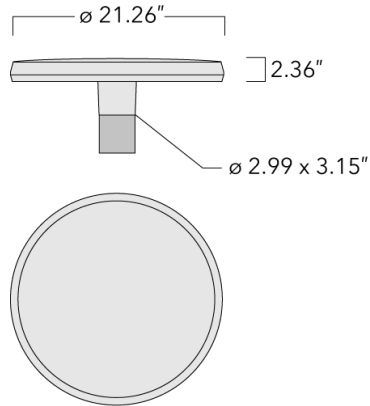

we-ef

RMT320 LED Two-sided



Specifications

Material description

| | |
|----------------------|--|
| Body | Marine-grade, die-cast aluminium alloy |
| Lens | RFC® Reflection Free Contour technology |
| Colors |  RAL9004 Black  RAL9007 Grey Metallic  RAL9016 White  RAL8019 Dark Bronze |
| Gasket | Silicone CCG® Controlled Compression Gasket |
| Fasteners | PCS Polymer Coated Stainless Steel Hardware |
| Ingress protection | IP66 |
| Impact resistance | IK09 |
| Corrosion resistance | 5CE |

Electrical description

| | |
|------------------|----------------------------------|
| Power supply | 220-240V / 50-60 Hz |
| Driver / Ballast | Integral EC electronic converter |
| Power factor | > 0.9 |

WE-EF LIGHTING USA, LLC

410-D Keystone Drive, 15086 Warrendale, PA 15086 - Phone: +1 724 742 0030

customersupport.usa@we-ef.com - <https://we-ef.com/us>

Subject to technical changes and errors. - Generated on 11/23/2024

105-9925-70

we-ef

RMT320 LED Two-sided

Additional information

Lifetime

Ta=25°/40° L90B10 > 90000h

WE-EF LIGHTING USA, LLC

410-D Keystone Drive, 15086 Warrendale, PA 15086 - Phone: +1 724 742 0030
customersupport.usa@we-ef.com - <https://we-ef.com/us>

Subject to technical changes and errors. - Generated on 11/23/2024