



Beschreibung

IP66, SKI. SKII auf Anfrage. IK08. Korrosionsbeständiger Aluminiumguss. PCS beschichtete Edelstahlschrauben. 5CE Korrosionsschutz. CCG® Silikondichtung. Sicherheitsglas, abklappbar. CAD-optimierte OLC® Technik zur Lichtlenkung und Entblendung.

Variante mit 2200 K bis max. 1050 mA erhältlich, bei Bestellung bitte angeben.

Ausleger sind separat zu bestellen.

Gewicht	13.50 kg
Lichtverteilung	asymmetrisch vorwärts, breitstrahlend [R65]
Lichtquelle	LED-18/36W / 700 mA - 2700 K
CRI	70
Netz	EVG
LEDs	18
Bemessungsleistung	41 W
Nominal Lichtstrom (lm)	
LED Lumen	290
Total Lumen	5220
Tj	85
Bemessungslichtstrom (lm)	
LED Lumen	211.7
Total Lumen	3810.7
Ta	25

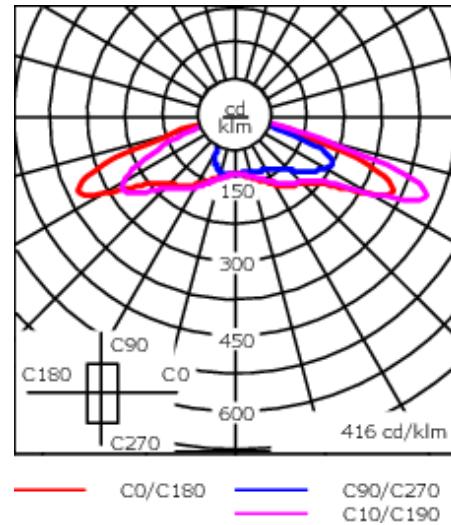
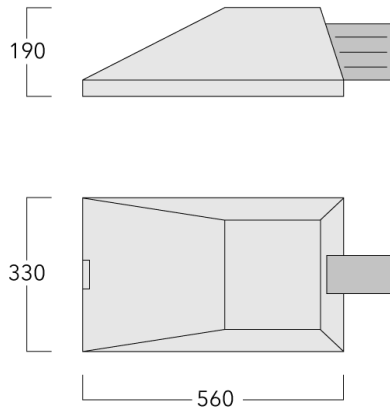

Spezifikationen

Materialbeschreibung

Gehäuse	Korrosionsbeständiger Aluminiumguss
Abdeckung	Sicherheitsglas, abklappbar
Farben	<div style="display: flex; align-items: center;"> <div style="width: 20px; height: 15px; background-color: black; margin-right: 5px;"></div> <div>RAL9004 Signalschwarz</div> </div> <div style="display: flex; align-items: center; margin-top: 5px;"> <div style="width: 20px; height: 15px; background-color: gray; margin-right: 5px;"></div> <div>RAL9007 Graualuminium</div> </div> <div style="display: flex; align-items: center; margin-top: 5px;"> <div style="width: 20px; height: 15px; background-color: darkgray; margin-right: 5px;"></div> <div>RAL7016 Anthrazitgrau</div> </div> <div style="display: flex; align-items: center; margin-top: 5px;"> <div style="width: 20px; height: 15px; background-color: lightgray; margin-right: 5px;"></div> <div>RAL9016 Verkehrsweiß</div> </div>
Dichtung	CCG® Silikondichtung
Schrauben	PCS beschichtete Edelstahlschrauben
Schutzart	IP66
Schlagfestigkeit	IK08
Korrosionsbeständigkeit	5CE
Windangriffsfläche	0.075 m ²

Elektrische Beschreibung

Netz	220-240V / 50-60 Hz
Netzgerät / Vorschaltgerät	Eingebaute elektronische Betriebsgeräte. DALI
Leistungsfaktor	> 0.9

Weitere Informationen

Lebensdauer Ta=25° L90B10 > 90000h

Energieeffizienzklasse C-D (Lichtquelle)

Steuerung

Eco Step Dim® Basic

Beschreibung	Artikelnummer
Eco Step Dim® Basic LED	430-0001

Eco Step Dim® Advanced

Beschreibung	Artikelnummer
Eco Step Dim® Advanced LED	430-0002

Montagezubehör

Wand- und Mastausleger KI

Beschreibung	Artikelnummer	A	C1	D1	D2	H1	M1	Gewicht (kg)	Alpha	C	D	H
KI0-240/260 Wandausleger	108-0493	±30°	210	180	140		12	5.70	±3°	210	180	180

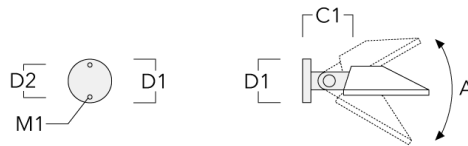

KI1-240 Mastausleger, einfach	108-0491	±30°	210			525		6.90	+15° / -30°	210		525
-------------------------------	----------	------	-----	--	--	-----	--	------	-------------	-----	--	-----

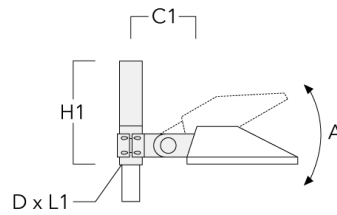

PFL240 LED

Beschreibung	Artikelnummer	A	C1	D1	D2	H1	M1	Gewicht (kg)	Alpha	C	D	H
KI2-240 Mastausleger, zweifach	108-0492	±30°	210			525		8.60	+15° / -30°	210		525

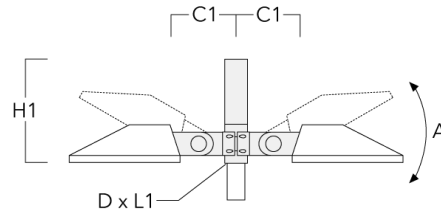

Mastausleger KL

Beschreibung	Artikelnummer	C1	D x L1	H1	Gewicht (kg)	C	H
KL1-240 Mastausleger, einfach	108-0342	735	76 x 130	750	9	725	750

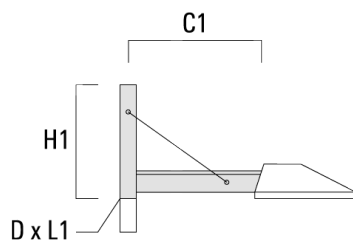

PFL240 LED

Beschreibung	Artikelnummer	C1	D × L1	H1	Gewicht (kg)	C	H
KL2-240 Mastausleger, zweifach	108-0532	735	76 x 130	750	14	725	750

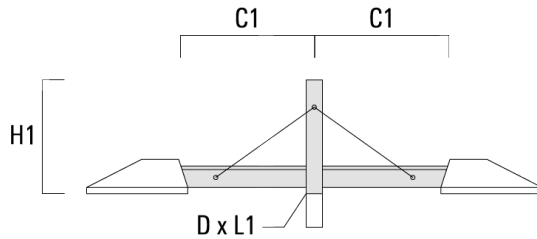

Wand- und Mastausleger KP

Beschreibung	Artikelnummer	C1	D1	D2	D × L1	H1	M1	Gewicht (kg)	C	D	H
KP0-240 Wandausleger	108-0103	200	230	195			12 2		175	230	230

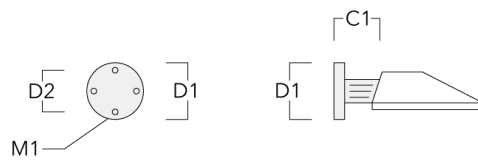

PFL240 LED

Beschreibung	Artikelnummer	C1	D1	D2	D x L1	H1	M1	Gewicht (kg)	C	D	H
KP1-240 Mastausleger, einfach	108-0104	215			76 x 80	575		3.80	175		575

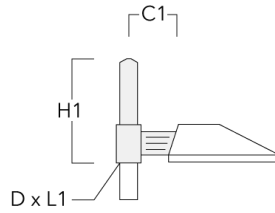

KP2-240 Mastausleger, zweifach	108-0105	215			76 x 80	575		3.80	175		575
--------------------------------	----------	-----	--	--	---------	-----	--	------	-----	--	-----

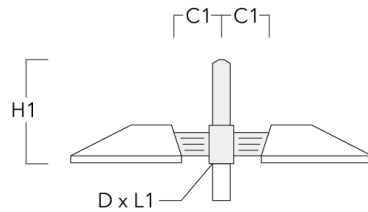

PFL240 LED

Mastausleger KP_L

Beschreibung	Artikelnummer	C1	D x L1	H1	Gewicht (kg)	C	H
KP1-L-240 Mastausleger, einfach	108-0268	635	76 x 130	575	9.10	175	575

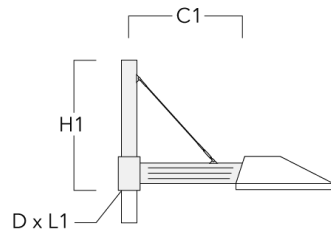

KP2-L-240 Mastausleger, zweifach	108-0373	635	76 x 130	575	15	175	575
----------------------------------	----------	-----	----------	-----	----	-----	-----

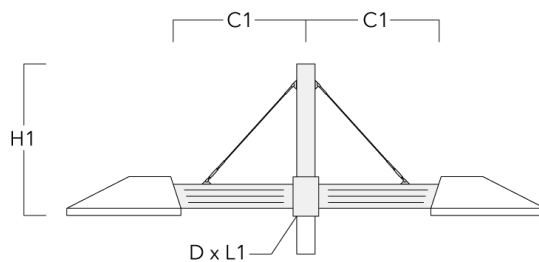

PFL240 LED

Mastausleger KX

Beschreibung	Artikelnummer	C1	D x L1	H1	Gewicht (kg)	C	H
KX1-240 Mastausleger, einfach	108-0343	735	76 x 130	410	7	725	410

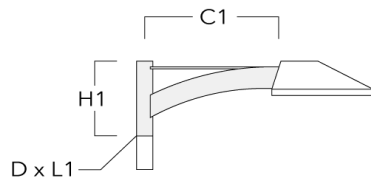

KX2-240 Mastausleger, zweifach	108-0534	735	76 x 130	410	11	725	410
--------------------------------	----------	-----	----------	-----	----	-----	-----

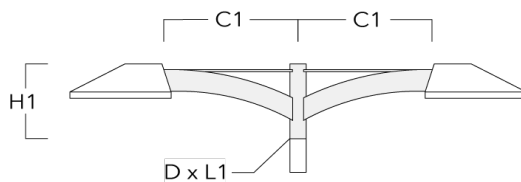

PFL240 LED

Mastausleger KY

Beschreibung	Artikelnummer	A	C1	D × L1	H1	Gewicht (kg)	Alpha	C	H
KY1-240 Mastausleger, einfach	108-0500	±30°	210	76 x 80	930	9.90	+15°/-30°	210	575

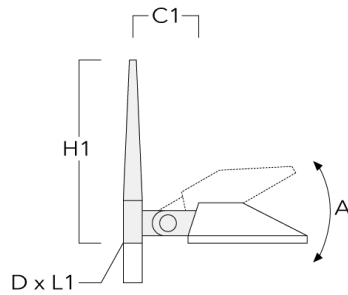

KY2-240 Mastausleger, zweifach	108-0501	±30°	210	76 x 80	730	12.80	+15°/-30°	210	575
--------------------------------	----------	------	-----	---------	-----	-------	-----------	-----	-----



PFL240 LED

Mastschellen SI

Beschreibung	Artikelnummer	C1	D1	Gewicht (kg)	C
SI1-240/260 Mastschelle, einfach (Ø 76-89)	108-0482	210	76-89	3.60	210

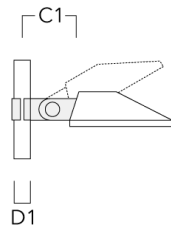

SI1-240/260 Mastschelle, einfach (Ø 114-133)	108-0483	210	114-133	4.40	210
--	----------	-----	---------	------	-----

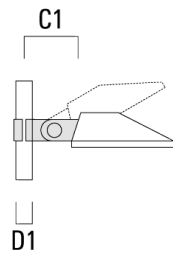

PFL240 LED

Beschreibung	Artikelnummer	C1	D1	Gewicht (kg)	C
SI1-240/260 Mastschelle, einfach (Ø 102-114)	108-0781	210	102-114	4	210

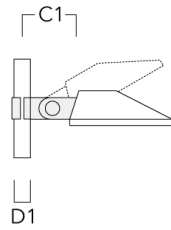

SI2-240/260 Mastschelle, zweifach (Ø 76-89)	108-0484	210	76-89	5.20	210
---	----------	-----	-------	------	-----

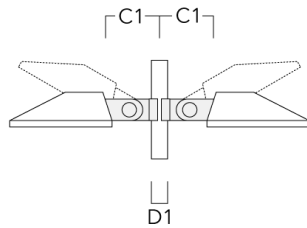

PFL240 LED

Beschreibung	Artikelnummer	C1	D1	Gewicht (kg)	C
SI2-240/260 Mastschelle, zweifach (Ø 114-133)	108-0485	210	114-133	6.20	210

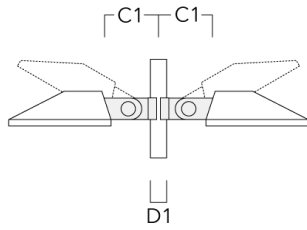

SI2-240/260 Mastschelle, zweifach (Ø 102-114)	108-0783	210	102-114	5.70	210
---	----------	-----	---------	------	-----

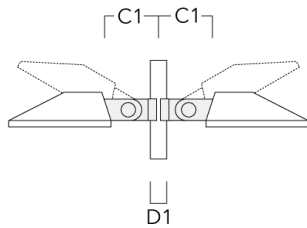

PFL240 LED

Mastschellen SK

Beschreibung	Artikelnummer	C1	D1	Gewicht (kg)	C
SK1-240 Mastschelle, einfach (Ø 102-114)	108-0782	175	102-114	3.40	175

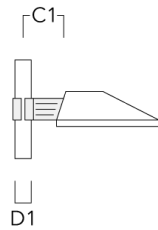

SK1-240 Mastschelle, einfach (Ø 76-89)	108-0788	175	76-89	3	175
--	----------	-----	-------	---	-----

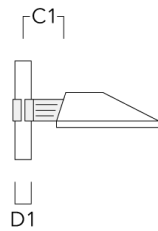

PFL240 LED

Beschreibung	Artikelnummer	C1	D1	Gewicht (kg)	C
SK1-240 Mastschelle, einfach (Ø 114-133)	108-0789	175	114-133	3.80	175

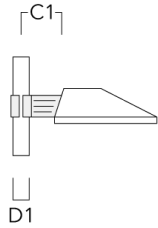

SK2-240 Mastschelle, zweifach (Ø 102-114)	108-0784	175	102-114	4.30	175
---	----------	-----	---------	------	-----

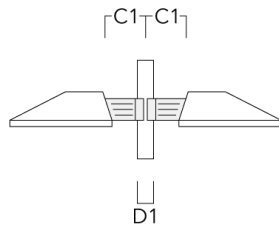

PFL240 LED

Beschreibung	Artikelnummer	C1	D1	Gewicht (kg)	C
SK2-240 Mastschelle, zweifach (Ø 76-89)	108-0790	175	76-89	3.90	175



SK2-240 Mastschelle, zweifach (Ø 114-133)	108-0791	175	114-133	4.70	175
---	----------	-----	---------	------	-----

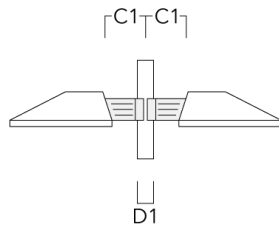

Optisches Zubehör**Blendschutz**

Beschreibung	Artikelnummer	Weitere Informationen
LS180-[A60]	430-0038	Blende LS180 zur Reduktion des rückseitigen Streulichts oder Beseitigung von Lichtimmissionen. PA Spritzguss-Komponente, matt schwarz. Geeignet für asymmetrische Lichtverteilung [A60].
LS180	430-0029	Blendschutz zur Reduktion des rückseitigen Streulichts. Blendschutz werkseitig eingebaut oder als Nachrüstsatz erhältlich. Geeignet für asymmetrische Lichtverteilung [S60],[S65],[S70],[R65],[P65], bei Bestellung bitte angeben.