



Beschreibung

IP66, SKI. SKII auf Anfrage. IK08. Korrosionsbeständiger Aluminiumguss. PCS beschichtete Edelstahlschrauben. 5CE Korrosionsschutz. CCG® Silikondichtung. Sicherheitsglas, abklappbar. CAD-optimierte OLC® Technik zur Lichtlenkung und Entblendung.

Variante mit 2200 K bis max. 1050 mA erhältlich, bei Bestellung bitte angeben.

Ausleger sind separat zu bestellen.

Gewicht	13.50 kg
Lichtverteilung	asymmetrisch vorwärts, breitstrahlend [R65]
Lichtquelle	LED-18/36W / 700 mA - 4000 K
CRI	70
Netz	EVG
LEDs	18
Bemessungsleistung	41 W
Nominal Lichtstrom (lm)	
LED Lumen	350
Total Lumen	6300
Tj	85
Bemessungslichtstrom (lm)	
LED Lumen	255.5
Total Lumen	4599.1
Ta	25

PFL240 LED

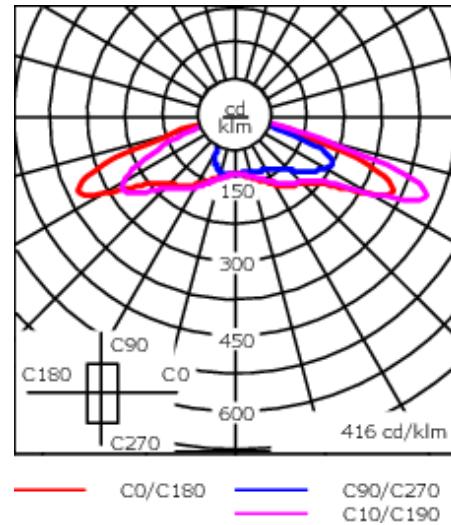
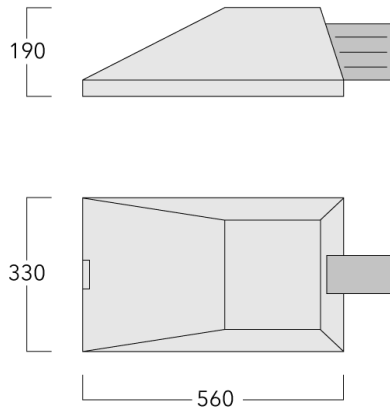

Spezifikationen

Materialbeschreibung

Gehäuse	Korrosionsbeständiger Aluminiumguss
Abdeckung	Sicherheitsglas, abklappbar
Farben	<div style="display: flex; align-items: center; gap: 10px;"> <div style="width: 20px; height: 15px; background-color: black; margin-right: 5px;"></div> RAL9004 Signalschwarz </div> <div style="display: flex; align-items: center; gap: 10px;"> <div style="width: 20px; height: 15px; background-color: gray; margin-right: 5px;"></div> RAL9007 Graualuminium </div> <div style="display: flex; align-items: center; gap: 10px;"> <div style="width: 20px; height: 15px; background-color: darkgray; margin-right: 5px;"></div> RAL7016 Anthrazitgrau </div> <div style="display: flex; align-items: center; gap: 10px;"> <div style="width: 20px; height: 15px; background-color: lightgray; margin-right: 5px;"></div> RAL9016 Verkehrsweiß </div>
Dichtung	CCG® Silikondichtung
Schrauben	PCS beschichtete Edelstahlschrauben
Schutzart	IP66
Schlagfestigkeit	IK08
Korrosionsbeständigkeit	5CE
Windangriffsfläche	0.075 m ²

Elektrische Beschreibung

Netz	220-240V / 50-60 Hz
Netzgerät / Vorschaltgerät	Eingebaute elektronische Betriebsgeräte. DALI
Leistungsfaktor	> 0.9

WE-EF Switzerland AG

Weitere Informationen

Lebensdauer Ta=25° L90B10 > 90000h

Energieeffizienzklasse C-D (Lichtquelle)

Steuerung

Eco Step Dim® Basic

Beschreibung	Artikelnummer
Eco Step Dim® Basic LED	430-0001

Eco Step Dim® Advanced

Beschreibung	Artikelnummer
Eco Step Dim® Advanced LED	430-0002

Montagezubehör

Wand- und Mastausleger KI

Beschreibung	Artikelnummer	A	C1	D1	D2	H1	M1	Gewicht (kg)	Alpha	C	D	H
KI0-240/260 Wandausleger	108-0493	±30°	210	180	140		12	5.70	±3°	210	180	180

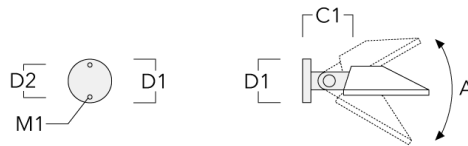

KI1-240 Mastausleger, einfach	108-0491	±30°	210			525		6.90	+15° / -30°	210		525
-------------------------------	----------	------	-----	--	--	-----	--	------	-------------	-----	--	-----

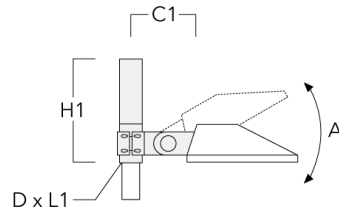

PFL240 LED

Beschreibung	Artikelnummer	A	C1	D1	D2	H1	M1	Gewicht (kg)	Alpha	C	D	H
KI2-240 Mastausleger, zweifach	108-0492	±30°	210			525		8.60	+15° / -30°	210		525

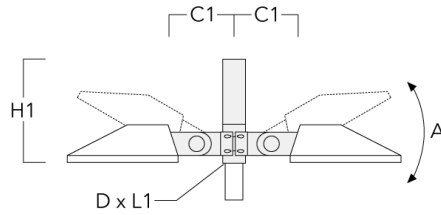

Mastausleger KL

Beschreibung	Artikelnummer	C1	D x L1	H1	Gewicht (kg)	C	H
KL1-240 Mastausleger, einfach	108-0342	735	76 x 130	750	9	725	750

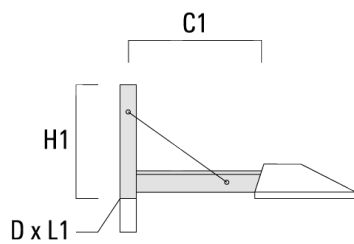

PFL240 LED

Beschreibung	Artikelnummer	C1	D × L1	H1	Gewicht (kg)	C	H
KL2-240 Mastausleger, zweifach	108-0532	735	76 x 130	750	14	725	750

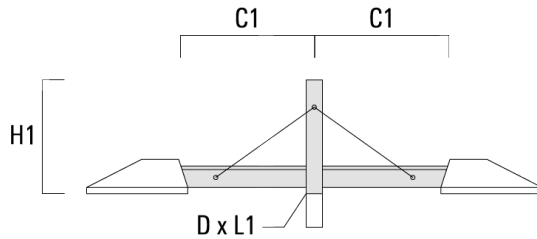

Wand- und Mastausleger KP

Beschreibung	Artikelnummer	C1	D1	D2	D × L1	H1	M1	Gewicht (kg)	C	D	H
KP0-240 Wandausleger	108-0103	200	230	195			12	2	175	230	230

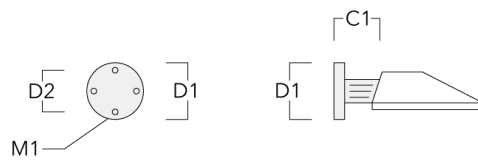

PFL240 LED

Beschreibung	Artikelnummer	C1	D1	D2	D x L1	H1	M1	Gewicht (kg)	C	D	H
KP1-240 Mastausleger, einfach	108-0104	215			76 x 80	575		3.80	175		575

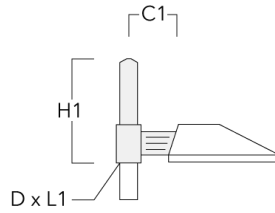

KP2-240 Mastausleger, zweifach	108-0105	215			76 x 80	575		3.80	175		575
--------------------------------	----------	-----	--	--	---------	-----	--	------	-----	--	-----

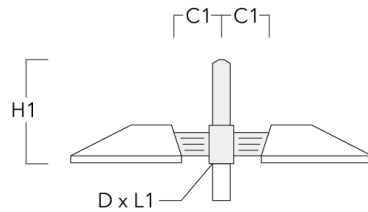

PFL240 LED

Mastausleger KP_L

Beschreibung	Artikelnummer	C1	D x L1	H1	Gewicht (kg)	C	H
KP1-L-240 Mastausleger, einfach	108-0268	635	76 x 130	575	9.10	175	575

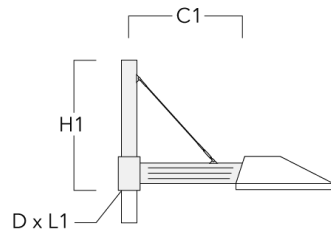

KP2-L-240 Mastausleger, zweifach	108-0373	635	76 x 130	575	15	175	575
----------------------------------	----------	-----	----------	-----	----	-----	-----

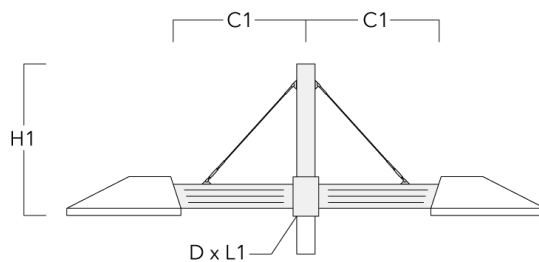

PFL240 LED

Mastausleger KX

Beschreibung	Artikelnummer	C1	D x L1	H1	Gewicht (kg)	C	H
KX1-240 Mastausleger, einfach	108-0343	735	76 x 130	410	7	725	410

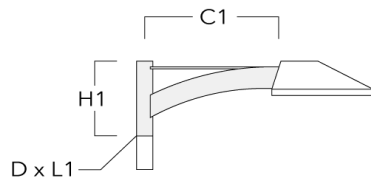

KX2-240 Mastausleger, zweifach	108-0534	735	76 x 130	410	11	725	410
--------------------------------	----------	-----	----------	-----	----	-----	-----

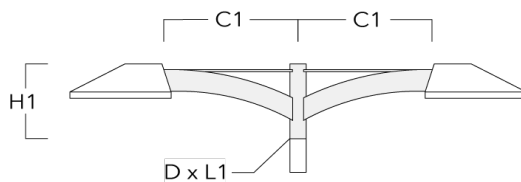

PFL240 LED

Mastausleger KY

Beschreibung	Artikelnummer	A	C1	D × L1	H1	Gewicht (kg)	Alpha	C	H
KY1-240 Mastausleger, einfach	108-0500	±30°	210	76 x 80	930	9.90	+15°/-30°	210	575

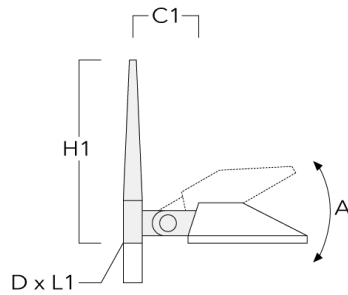

KY2-240 Mastausleger, zweifach	108-0501	±30°	210	76 x 80	730	12.80	+15°/-30°	210	575
--------------------------------	----------	------	-----	---------	-----	-------	-----------	-----	-----

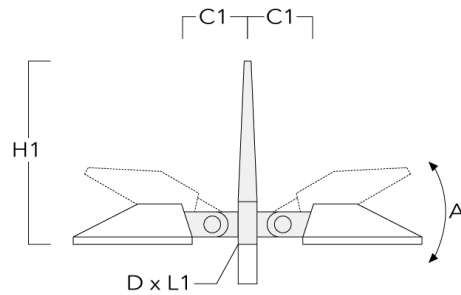

PFL240 LED

Mastschellen SI

Beschreibung	Artikelnummer	C1	D1	Gewicht (kg)	C
SI1-240/260 Mastschelle, einfach (Ø 76-89)	108-0482	210	76-89	3.60	210

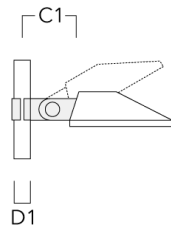

SI1-240/260 Mastschelle, einfach (Ø 114-133)	108-0483	210	114-133	4.40	210
--	----------	-----	---------	------	-----

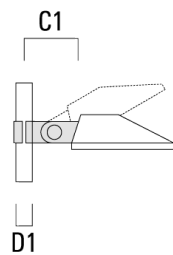

PFL240 LED

Beschreibung	Artikelnummer	C1	D1	Gewicht (kg)	C
SI1-240/260 Mastschelle, einfach (Ø 102-114)	108-0781	210	102-114	4	210

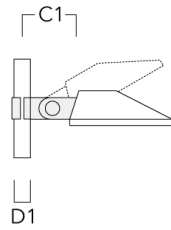

SI2-240/260 Mastschelle, zweifach (Ø 76-89)	108-0484	210	76-89	5.20	210
---	----------	-----	-------	------	-----

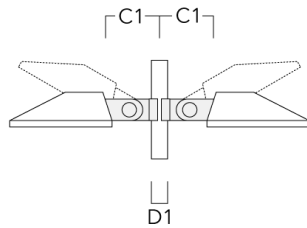

PFL240 LED

Beschreibung	Artikelnummer	C1	D1	Gewicht (kg)	C
SI2-240/260 Mastschelle, zweifach (Ø 114-133)	108-0485	210	114-133	6.20	210

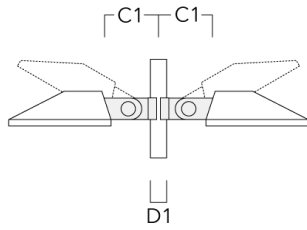

SI2-240/260 Mastschelle, zweifach (Ø 102-114)	108-0783	210	102-114	5.70	210
---	----------	-----	---------	------	-----

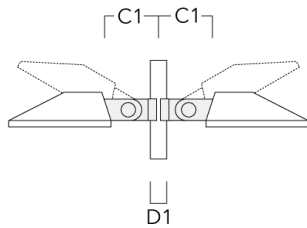

PFL240 LED

Mastschellen SK

Beschreibung	Artikelnummer	C1	D1	Gewicht (kg)	C
SK1-240 Mastschelle, einfach (Ø 102-114)	108-0782	175	102-114	3.40	175

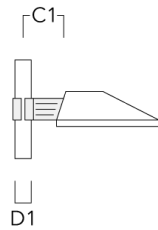

SK1-240 Mastschelle, einfach (Ø 76-89)	108-0788	175	76-89	3	175
--	----------	-----	-------	---	-----

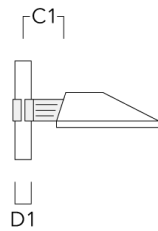

PFL240 LED

Beschreibung	Artikelnummer	C1	D1	Gewicht (kg)	C
SK1-240 Mastschelle, einfach (Ø 114-133)	108-0789	175	114-133	3.80	175

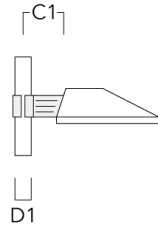

SK2-240 Mastschelle, zweifach (Ø 102-114)	108-0784	175	102-114	4.30	175
---	----------	-----	---------	------	-----

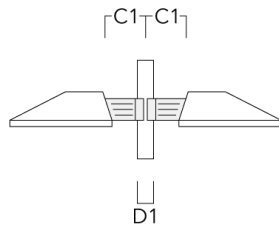

PFL240 LED

Beschreibung	Artikelnummer	C1	D1	Gewicht (kg)	C
SK2-240 Mastschelle, zweifach (Ø 76-89)	108-0790	175	76-89	3.90	175

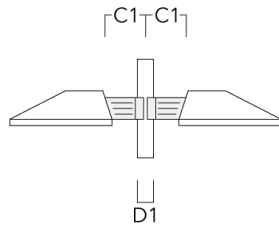

SK2-240 Mastschelle, zweifach (Ø 114-133)	108-0791	175	114-133	4.70	175
---	----------	-----	---------	------	-----

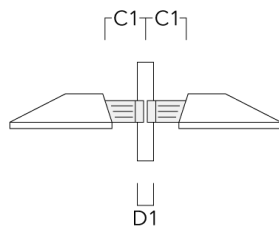

Optisches Zubehör**Blendschutz**

Beschreibung	Artikelnummer	Weitere Informationen
LS180-[A60]	430-0038	Blende LS180 zur Reduktion des rückseitigen Streulichts oder Beseitigung von Lichtimmissionen. PA Spritzguss-Komponente, matt schwarz. Geeignet für asymmetrische Lichtverteilung [A60].
LS180	430-0029	Blendschutz zur Reduktion des rückseitigen Streulichts. Blendschutz werkseitig eingebaut oder als Nachrüstsatz erhältlich. Geeignet für asymmetrische Lichtverteilung [S60], [S65], [S70], [R65], [P65], bei Bestellung bitte angeben.